

TABLE OF CONTENTS

I. CARE AND MAINTENANCE.....	2
II. TOOLS / MATERIALS, SEALANT REQUIREMENTS, & LOAD / ANCHOR INSTRUCTIONS	2
III. ASSEMBLY AND INSTALLATION	2
IV. ARCHE-DUCT OPENING VERIFICATION (SKIP IF NO ARCHE-DUCT)	3
V. OPENING, FRAME AND PANEL VERIFICATION	4
1. Opening Verification.....	4
2. Pre-Fit and Leveling.....	4
3. Flash the Opening.....	4
4. Arche-Duct Water Test	5
5. Arche-Duct Install	5
6. Confirm Weeping Slots	5
7. Backfill	5
VI. FRAME ASSEMBLY	5
VII. NAIL-FIN FRAME INSTALLATION.....	6
VIII. BLOCK FRAME INSTALLATION.....	7
IX. FLOOR CLOSER INSTALLATION.....	8
X. PANEL INSTALLATION.....	10
XI. FINISHED FLOORING INSTALLATION.....	11
XII. FLASHING AFTER INSTALLATION.....	11
APPENDIX A: ARCHE-DUCT DIMENSIONAL REFERENCES	12
APPENDIX B: RIXSON ADDITIONAL REFERENCES	13
APPENDIX C: HARDWARE LOCATIONS.....	14
APPENDIX D: CLIC GLASS INSTALLATION	15

I. Care and Maintenance

Operational Warning: Fleetwood products operate smoothly and special care should be taken by the owner to make sure users are not injured.

Prior to installation, store the door in a dry flat level surface that is elevated. **DO NOT** lean doors against walls (to prevent warping). **AVOID** contact with the ground, moisture, direct sunlight, or extreme temperatures during storage.

This product is factory finished. Please handle with extreme care. Protect all exposed surfaces from contact with caustics, corrosives, solvents, abrasions, impacts, wet packing material etc. **FAILURE TO DO SO WILL NULLIFY THE WARRANTY.** Before **ANY CLEANING**, review the Care & Maintenance Instructions (go to www.fleetwoodusa.com for more information). **Contact the local dealer with any questions or concerns.** Fleetwood strongly recommends that all products be cleaned after installation and totally protected from construction debris and equipment.

After Installation to prevent warping and cracking of the wood, avoid exposing the door to direct sunlight or humidity for prolonged periods. Wood naturally expands and contracts with temperature and humidity changes. To minimize these issues ensure the door is installed in an area with moderate and stable environmental conditions.

II. Tools / Materials, Sealant Requirements, & Load / Anchor Instructions

Tools Required: Tape measure, Soft mallet, Plumb bob / line, Flat head screwdriver, Laser Level or 8' level, Shims, Nails, Screws, Sealant, caulk gun, Backer Rod, Scissors or utility knife, hex keys, drill bit, drive bit and powered drill.

Sealant Requirements

- The sealant referred to within this document for seals associated with the assembly of the product should conform to **AAMA 800**. It is recommended that all other sealants conform to **AAMA 800** but may be a sealant recommended and approved by the sealant manufacturer that is compatible with the framing, finish, and surrounding materials.
- All sealant bead sizes must conform to the sealant manufacturers' size requirements.
- The Owner / General Contractor is responsible for identifying the need for any additional sealant to be applied by others. Such sealant shall be elastomeric material, with the framing, finish and surrounding materials.

Load / Anchor Instructions

- Live or Dead Loads can affect product functionality, loads shall be designed to withstand the most critical effects of load factors and load combinations as required by building code.
- Fleetwood requires maximum vertical deflection of the header not to exceed $\text{Span}/720$ or $1/8''$
- Structural engineer to determine anchor quantity and spacing for design load requirements.
- Review panel pressure loads and lateral force with flooring manufacturers specifications.
- Proper material must be used between all dissimilar materials (i.e. block/concrete & aluminum).

III. Assembly and Installation

General: The key to any window or door installation is preparation. This extends from storage of the product to the final installation and to all points in between. Careful planning and attention to detail can help ensure proper installation.

It is essential that each Fleetwood product be assembled and glazed in accordance with AAMA standards and factory instructions. It is the installer's responsibility to ensure that each Fleetwood product is assembled, glazed and installed and completely sealed to ensure that the product is leak-free and operates correctly. **Installation of Fleetwood products must be in accordance with the standards set forth in ASTM E 2112.** If there are any questions regarding the installation of a Fleetwood product contact the factory customer service department.

Fleetwood has provided this product with recommended weather-stripping. If the provided weather-stripping does not ensure an optimum fit the Fleetwood Authorized Dealer should contact Customer Service for an expedited NO CHARGE shipment of replacement weather-stripping.

IV. Arche-Duct opening verification (skip if no Arche-Duct)

Table 1: Arche-Duct Framing Dimensions

Model	A	B	C	D	E	F	G			
H40	N.F.W. + 1.00"	3.94"	6.94" Sillpan Tabs	4.25"	2.75" Sillpan Tabs	Pivot Location -1.50"	19"			
H28								A - (D+E)	8.19"	9.69" Sillpan Tabs
Pivot Set										

For additional dimensions see Appendix A.

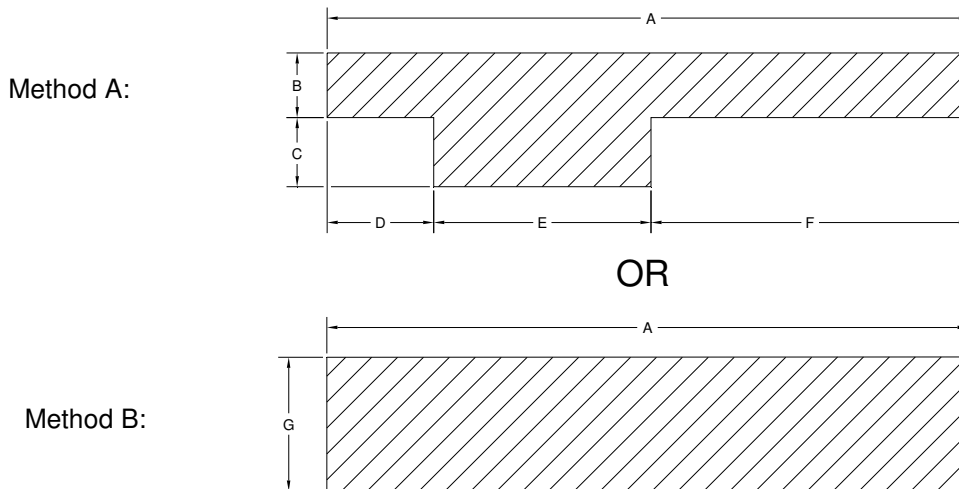
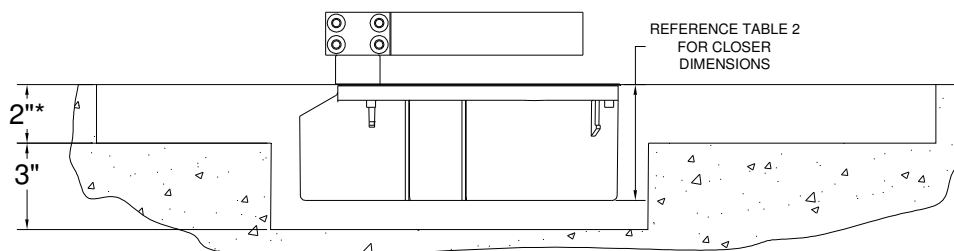

Figure 1:
Arche-Duct Framing (Top View)



* Minimum depth required for Arche-Duct and Rixson closer. Additional depth may be required for drainage. Side drains sit $\frac{3}{16}$ " below bottom of Arche-Duct

Figure 2:
Rixson Arche-Duct Opening (Side View)

V. Opening, Frame and Panel Verification

1. Opening Verification

- Check the measurements of the opening and verify that the door will fit into the opening. Measure all four sides of the opening to make sure it is 1/2" larger than the doors in width and 1/4" in height.
- Verify the opening is plumb, square, and level (Figure 3).
- Verify location / dimension Arche-Duct opening (Figure 1,2).
- Remove the frame from packaging (save all red bag items for use later) and lay it in front of the opening. Check door net frame width / height dimensions and verify pivot distance (per order).

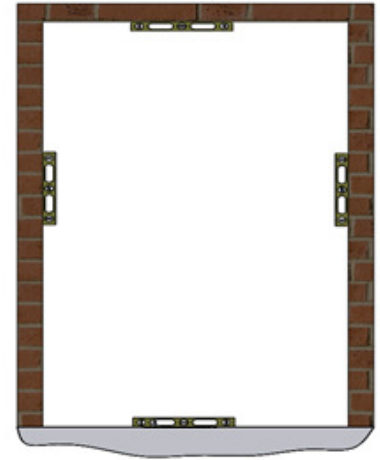

Figure 3:
Level Locations

2. Pre-Fit and Leveling

Note: Do not leave the Arche-Duct system exposed for more than 3 months. Prolonged exposure will damage the powder coated finish.

- Place the Arche-Duct drain system into the opening and determine any leveling that must be done prior to installation (Figure 3). Prepare relief areas for the PVC drain flange(s).
- Shim as necessary to stabilize the entire depth and length of the Arche-Duct. No unsupported width of more than 8" is allowed. Shim to be load bearing, non-porous, non-absorbent and inorganic.
- If more than 1/8" shim height is required, it is recommended that pouring self-leveling "Rock Hard" (or equal) to achieve level and stable surface.

3. Flash the Opening

- Once the opening has been confirmed, flashing of the opening is required prior to Frame installation. Paper and/or liquid flashing methods are acceptable (see AAMA 711/714 for material requirements).
- Check local Building codes for any additional flashing requirements.

Paper Flashing

- At each Jamb the flashing paper should be cut at least 3" past the weep-screed or diado flashing and at least 6" above the head of the door. The flashing must wrap around the jamb and at least 3" back into the opening.
- At the Head run the flashing paper long enough to extend at least 3" past the jamb flashing and wrap around the Header at least 3" into the opening.

Liquid Flashing

- Follow the liquid flashing manufacturer instructions.

4. Arche-Duct Water Test

Note: Installer responsible for verifying the integrity of the Arche-Duct for water leakage and performance.

- Block all drain outlets and fill the Arche-Duct with water to verify the integrity of all seams and drain connections. Look for leak points, the water level of the Arche-Duct should remain constant. If the Arche-Duct passes water test, drain Arche-Duct and continue with installation of frame.

5. Arche-Duct Install

Note: Do not leave the Arche-Duct system exposed for more than 3 months. Prolonged exposure will damage the powder coated finish.

- Confirm proper orientation of Arche-Duct for tracks and drain location with customer order and/or dealer drawings.
- Install Arche-Duct into already leveled opening. An insulating material should be placed between the Arche-Duct and the supporting structure (concrete, steel, etc.) to prevent corrosion of the aluminum Arche-Duct.
- Connect tubing or pipe to Arche-Duct drain connections.

6. Confirm Weeping Slots

- Typical weep slot quantity to be 3 per single panel configuration.

7. Backfill

- Do not back-fill until door operation is fully tested, including locking into jamb(s) and locking into pocket interlocker (when applicable).
- Verify you have access to drainage connections and clean out as necessary.

VI. Frame Assembly

Note: Failure to assemble the frame according to the installation instructions, nullifies warranties related to this product.

- Apply a compatible sealant to the corners of the frame. Assemble the frame with screws provided (Figure 4).

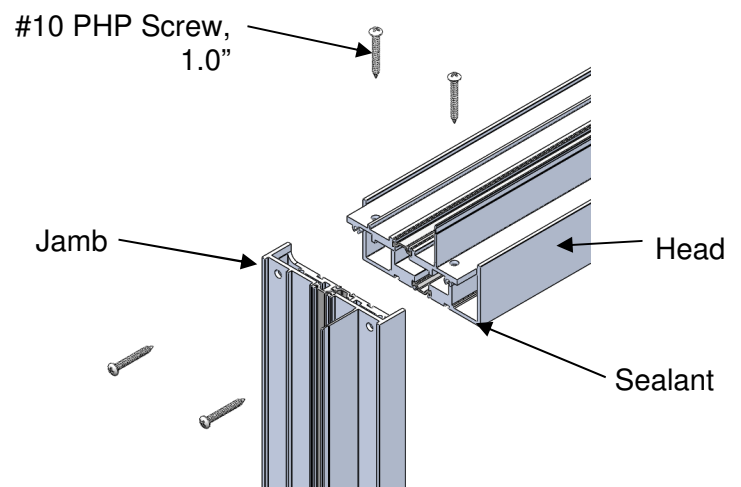

Figure 4:
Frame Assembly

VII. Nail-fin Frame Installation

Note: Fleetwood recommends the use of a laser level or 8' level for frame installations. Cross-measure within $\pm 1/32"$ for interior and exterior.

1. Seal frame and vent joints completely with compatible sealant.
2. Insert the frame into the Arche-Duct. Cross-measure and adjust to achieve a plumb square and level condition. Shim where needed. Seal all fastener heads with compatible sealant.
3. Secure Top pivot to header with #10 screw min. 4" long (not by Fleetwood). See Figure 5 for illustration.

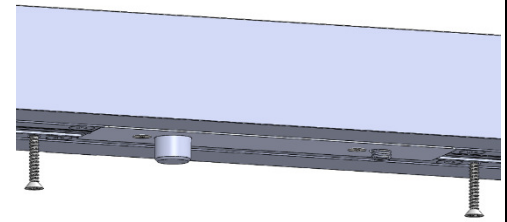

Figure 5:
Securing Top Pivot
(Nail-fin Frame Shown)

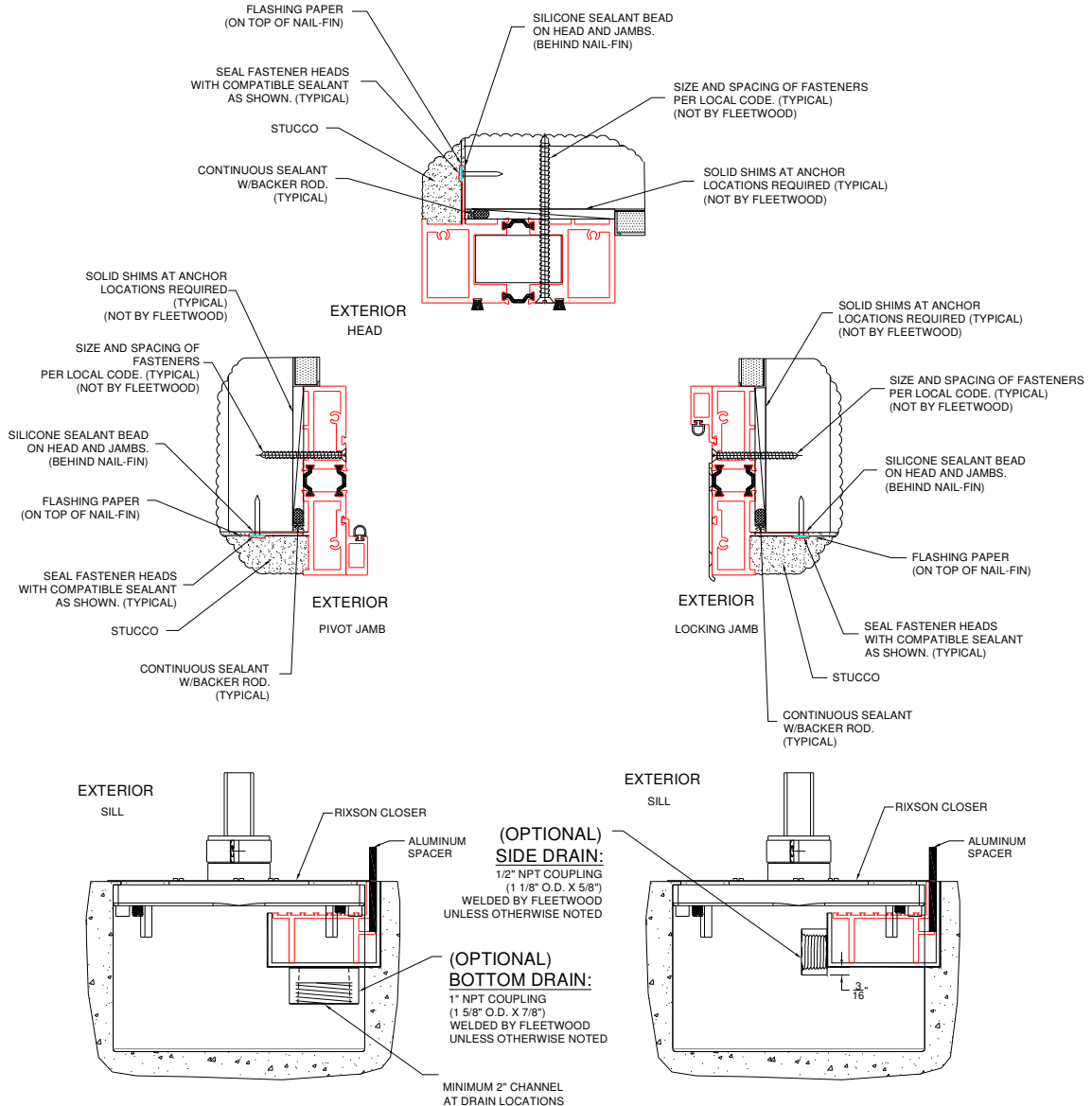

Figure 6:
Rixson Nail-fin Frame Installation

VIII. Block Frame Installation

Note: Fleetwood recommends the use of a laser level or 8' level for frame installations. Cross-measure within $\pm 1/32"$ for interior and exterior.

1. Seal frame and vent joints completely with compatible sealant.
2. Insert the frame into the Arche-Duct. Cross-measure and adjust to achieve a plumb square and level condition. Shim where needed. Seal all fastener heads with compatible sealant.
3. Secure Top pivot to header with #10 screw min. 4" long (not by Fleetwood). See Figure 7 for illustration.

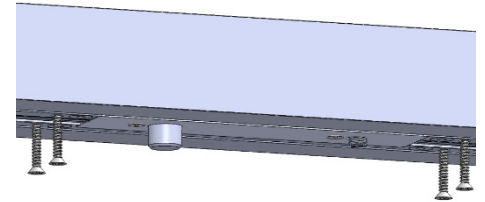

Figure 7:
Securing Top Pivot
(Block Frame Shown)

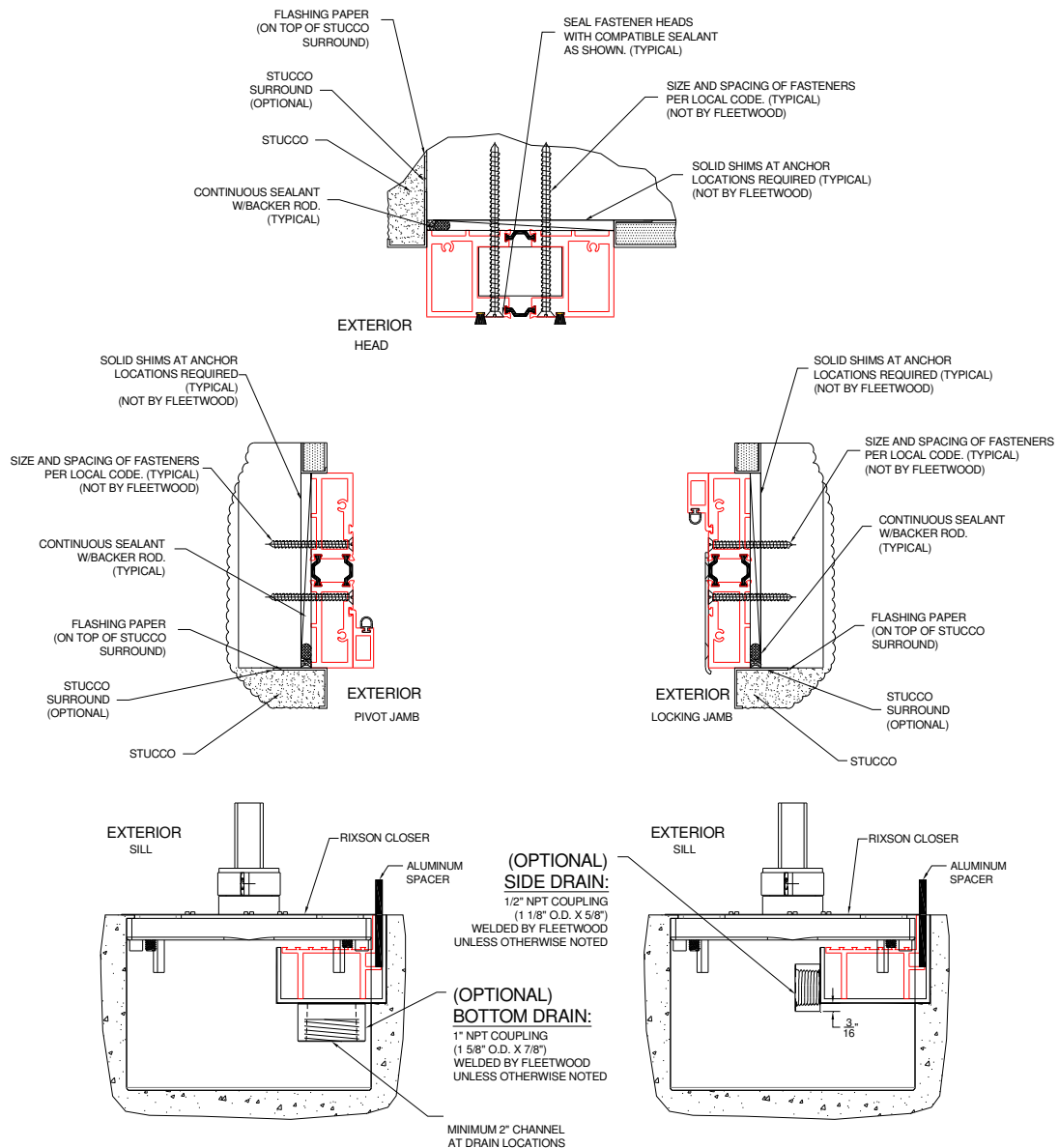

Figure 8:
Rixson Block Frame Installation

IX. Floor Closer Installation

1. Set the closer into the floor 2-1/16" from the back of the jamb and level (confirm with plumb line as stated in step 4). Closer is to be installed in line to the door and flush to the floor (Figure 9).
2. Measure dimension of "A" as specified from opening to the spindle center (Figure 10 & Table 2).
3. Set closer surface flush with the finished floor. Continue to step 4.

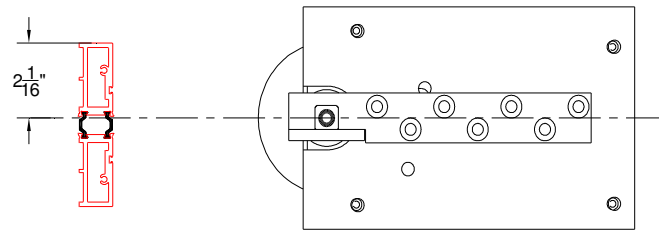

Figure 9:
Closer Positioning

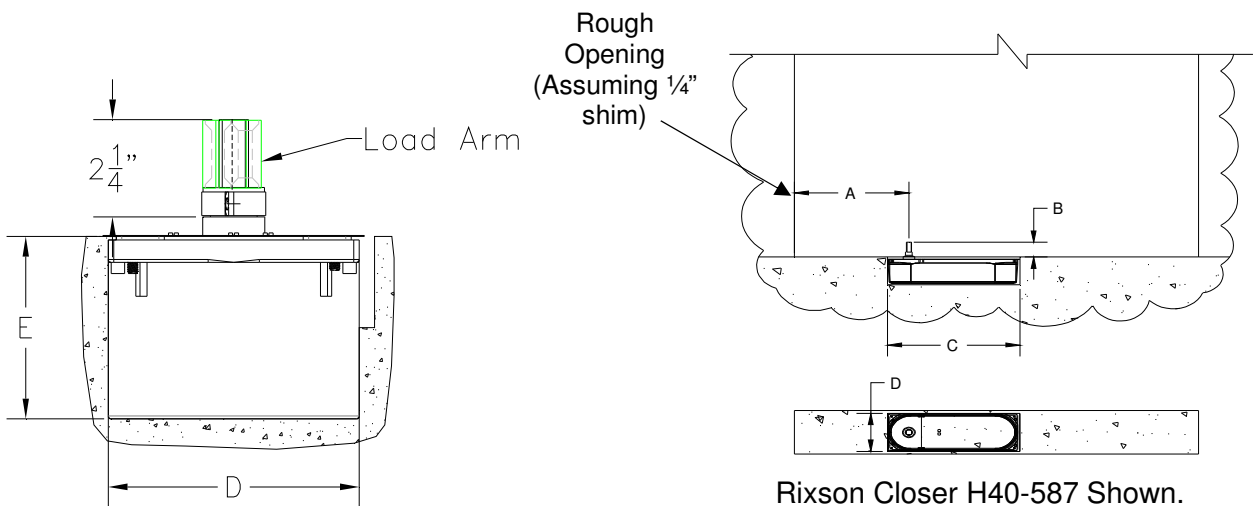

Figure 10:
Frame, Closer, Pivot Opening

Table 2: Pivot Location, Floor Closer & Pivot Set Dimensions.

Model	A	B	C*	D*	E*
H40-587	Pivot Location + 1.25"	2.375"	17.25"	6.125"	4.063"
H28-587			11.375"	6.125"	4.063"
Pivot Set H117 3/4-587			6.5"	5.5"	2.375"

* Hole rough opening: add a minimum 1.0" around the closer (& pivot set) for cement or equivalent back fill.

4. Use a plumb line to center top pivot pin with center of closer spindle (Figure 11).

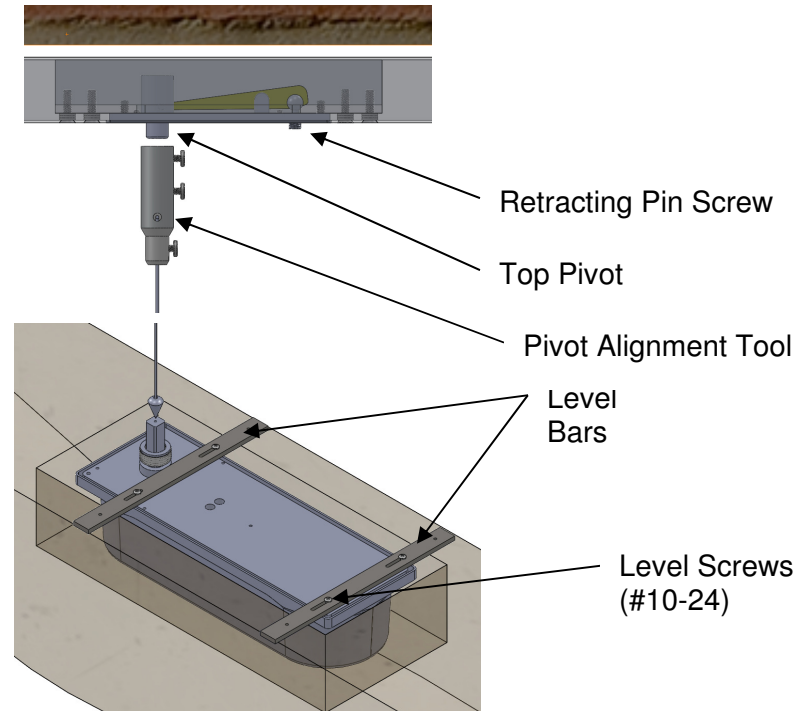
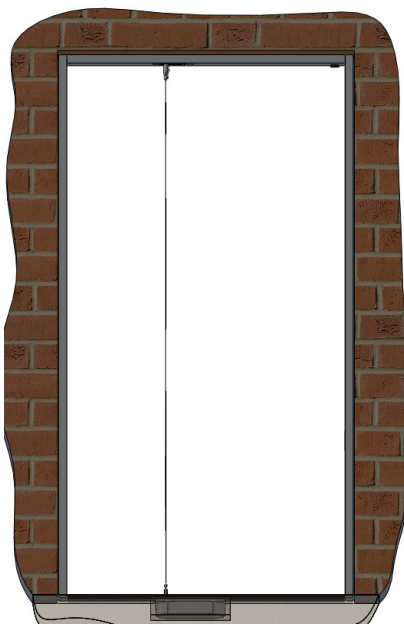

Figure 11:
In-line Verification

5. Grout in closer with cement or equivalent. Continue to Section XI when cement is cured.
6. Complete flooring around closer and Arche-Duct.
7. Install cover plates to closer.

X. Panel Installation

- **Closing Speed Adjustment** see Appendix B.
- **Handle Pull Installation** see Appendix D.

1. Retract top pivot pin by turning retracting pin screw counterclockwise (Figure 12). Install washer & thrust bearing to spindle (Figure 13).
2. With the floor closer in the slowest settings use a crescent wrench to turn the pivot perpendicular to the frame.
3. Tilt door to place on spindle and attach arm end block but do not tighten (Figure 13).
4. Align the two portions of top pivot and turn pin retracting screw clockwise (Figure 12).
5. Tighten arm end blocks screws and install load arm cover plate.
6. To complete the panel installation, apply backer rod and a complete bed of sealant to the entire exterior and interior joint between the frame and the building structure. Tool the sealant to eliminate bubbles, voids and / or breaks and ensure a completely watertight seal (Figure 6,8).

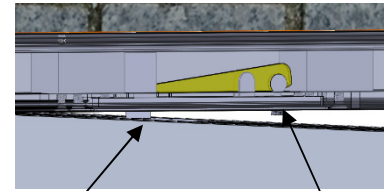

Archetype Head Pivot Retracting Pin

Figure 12:
Top Pivot Locking

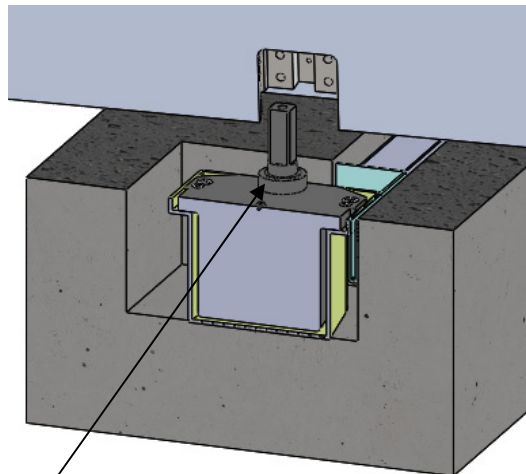

.100" thick Washer is under Thrust Bearing

Figure 13:
Washer Location

XI. Finished Flooring Installation

Flooring Material: The sill for this product was designed to incorporate the finished flooring as a key component to the bottom rail sealing and the linear slot drain. The material chosen to surround the extruded sill should be such that water will not damage it.

Linear Slot drain: The sill comes with an aluminum spacer to ensure the linear slot drain spacing is correct. This spacer is to be removed after the flooring is installed.

XII. Flashing after Installation

The flashing paper referred to in this document is Moistop or other code compliant flashing material that conforms to **Federal Specification UU-B-790a, Type 1, Grade A, Style 4**. The strips of flashing paper are to be no less than 9 inches wide (or wider as required by local codes). Flashing paper must be applied with galvanized nails or corrosion resistant staples. Flashing paper shall be applied in a weatherboard fashion around the full perimeter of the framed opening.

1. Once satisfied that the frame is water tight, and immediately prior to application of the flashing paper at the head and jambs, apply a continuous bead of sealant to the exposed mounting flange (nail-fin) at the top (head) and sides (jambs) of the installed frame. Also, apply sealant at corners of the frame, the full length of the seams where the nail fin flashing is mounted.
2. At each jamb, embed the flashing paper into the sealant onto mounting flange and fasten into place. The flashing paper should be cut sufficiently long enough to extend at least 3" past the weep-screed or diado flashing and at least 6 inches above the head of the window (Figure 14).
3. Finally, at the head, embed the flashing into the sealant on the mounting flange and fasten into place. The flashing paper should be cut sufficiently long enough to extend past the flashing paper at each jamb by at least 3" (Figure 15).
4. Weather resistant building paper should be applied in a weatherboard fashion to complete the installation (Figure 16).

Note: Where weather resistant building paper, insulating board, or other materials by other trades may constitute the primary weather barrier behind the exterior wall finish (i.e. stucco, masonry, siding, etc.), the owner / General Contractor are responsible to ensure that the weather barrier is continuous by effectively sealing the material to the window frame.

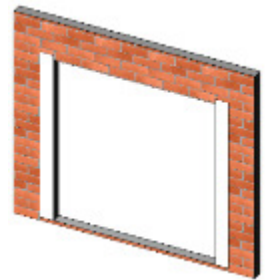

Figure 14:
Jamb flashing

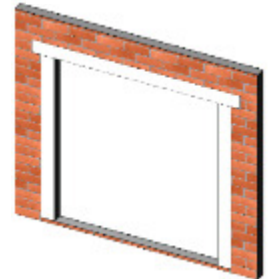

Figure 15:
Head Flashing

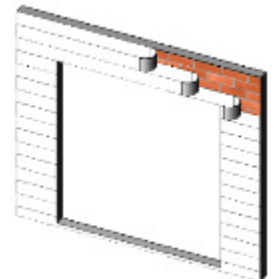

Figure 16:
Building Flashing

Appendix A: Arche-Duct Dimensional References

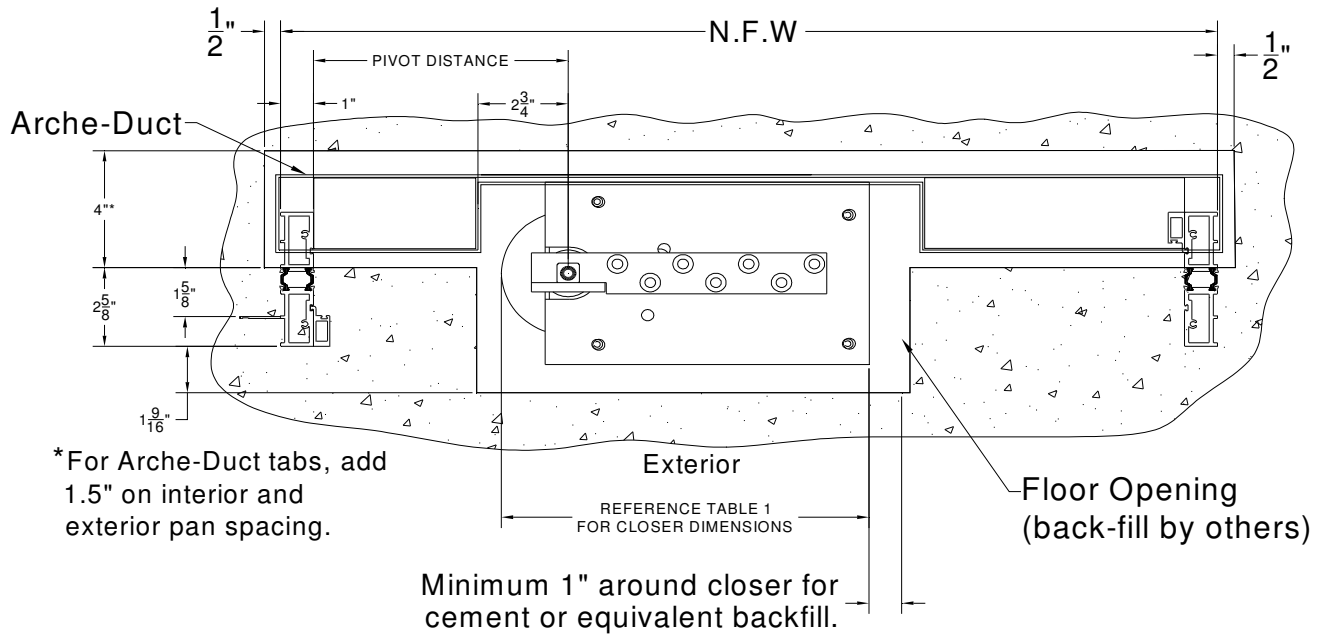

Figure A1:
 Rixson Arche-Duct Opening

Appendix B: Rixson Additional References

Closer Adjustment

PAGE 4



This Set Screw Is On Selector Hold-open Types Only

Closing speeds can be adjusted to suit local conditions and requirements. Label on closer face designates the purpose of each adjustment screw. Adjustments are for speed control.

Do not use Backcheck as deadstop. This is an intensity valve not speed control.

- A. The Delay Action valve allows adjustment from full open to 65° closed position. (Optional)
- B. The Closing Speed valve allows adjustment from full open to 15° on units without the Delay Action feature.
- C. The Closing Speed valve allows adjustment from 65° to 15° closed position on closers with Delay Action feature.
- D. Latch valve allows adjustment from 15° to closed position.
- E. Important: Backcheck adjustment must be adjusted to vary resistance from light to firm at 60° of door open.

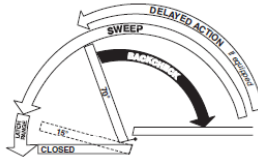

Closer Type

This closer is one of three types as follows:

- 1. Non hold-open factory set. No hold-open adjustments.
- 2. Automatic hold-open factory set. No hold-open adjustment.
- 3. Selective (on-off) hold-open label will indicate position of on-off selector screw. When turned "on", closer has automatic hold-open; turned "off", hold-open will not function. Turn full 180°.

Spring Power Adjustments

This closer can be adjusted for increased or decreased spring power.

These adjustments if required should be done by an authorized repair agency.

Repairs, parts replacement or internal adjustments must be done by a Rixson authorized repair agency. Consult www.rixson.com for an authorized repair agency in your area.

ASSA ABLOY is the global leader in door opening solutions, dedicated to satisfying customer needs for security, safety and convenience. Rixson® is a registered trademark of Yale Security Inc., an ASSA ABLOY Group company. Copyright© 2006, Yale Security Inc., an ASSA ABLOY Group company. All rights reserved. Reproduction in whole or in part without the express written permission of Yale Security Inc. is prohibited.

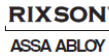

Rixson Specialty Door Controls

www.rixson.com

866-474-9766 Technical Department

RIXSON

ASSA ABLOY

Installation Instructions

IS2800587 (07-09)

H28 x 587 Arm Floor Closer
Center Hung Single Acting – Handed
H340 Top Pivot – Non Handed

Template

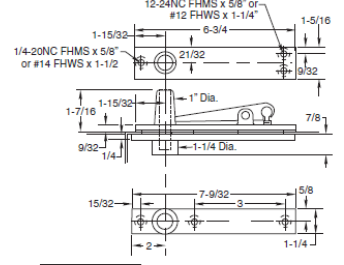
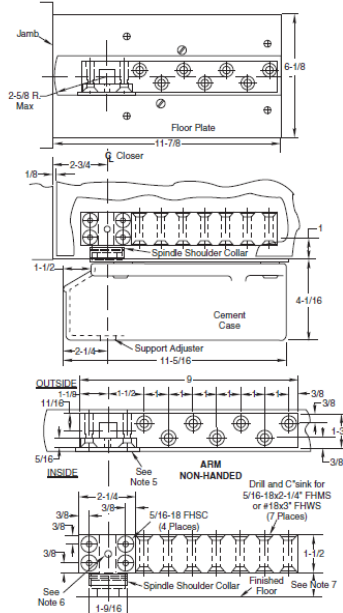

Max. Door Clearance	
Floor Plate	1"
1/2" Threshold	5/8"
1/4" Threshold	7/8"

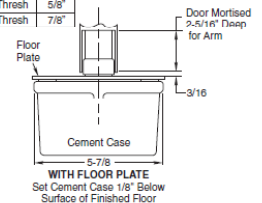

WITH FLOOR PLATE
Set Cement Case 1/8" Below Surface of Finished Floor

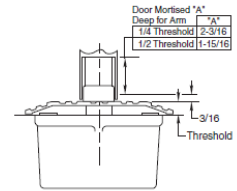

WITH THRESHOLD
Set Cement Case Flush with Finished Floor

- Notes:**
1. Do not scale drawing.
 2. Suitable reinforcing by others.
 3. Rixson design threshold available on request.
 4. For wood doors predrill arm and top pivot holes to prevent splitting.
 5. Door must have removable panel (by others) for access to arm screws. Removable panel must be on inside of door.
 6. Drill and tap for #8-32 machine screw, centered (screw by others).
 7. All dimensions given in inches. Conversion from inches to metric: inch x 25.4.

Rixson Specialty Door Controls

www.rixson.com

866-474-9766 Technical Department

Figure B1:
Rixson Closer Adjustments

Appendix C: Hardware Locations

The following are latching hardware locations to avoid when installing **surface mount handle pulls**.

Note: After any holes are drilled into the product, a small amount of silicone should be applied to the exposed surfaces.

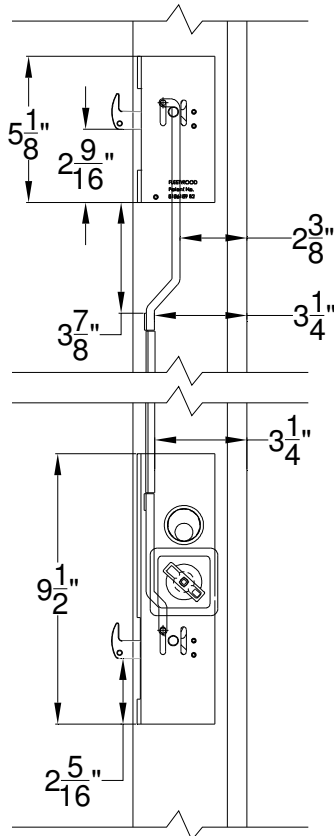

Figure C1:
 Archetype Latch and Secondary Latch

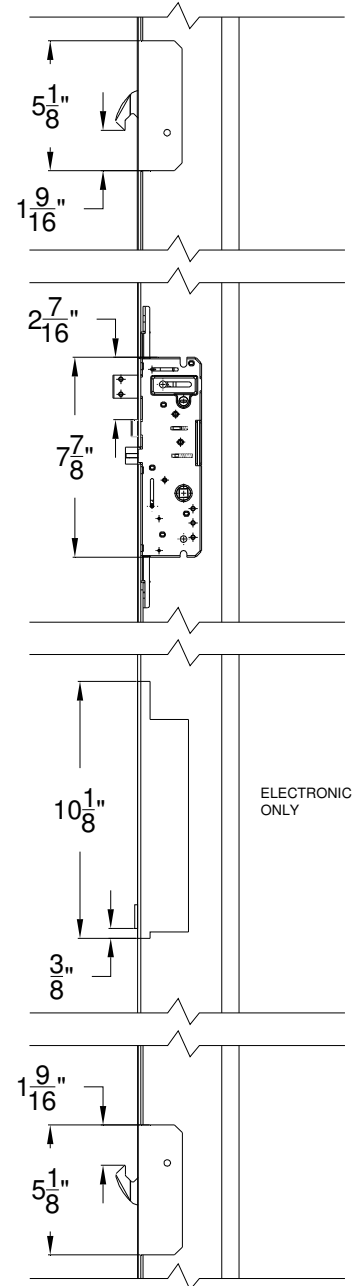

Figure C2:
 5 Point Latch / Electronic Latch

Appendix D: CLiC Glass Installation

Fleetwood offers CLiC on demand Privacy Glass as a glazing option. This type of glazing option requires power to be run to each lite using cardinals proprietary glass controller. Depending on the type of product ordered, the wire leads locations will vary. Please ask at the time of purchase to confirm where these leads will be located so assist in preparing the opening accordingly.

Below are links to CLiC glass specific installation instructions:

[Quick Start Guide](#)

[Installation Manual](#)

[Technical Data Sheet](#)