

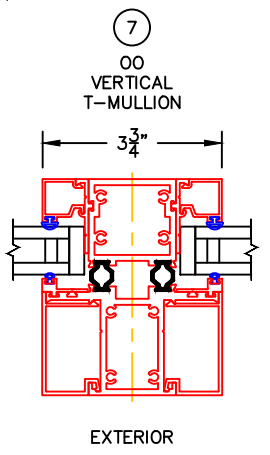

(USE RULER TO SCALE DIMENSIONS IN INCHES)

SCALE: 1/4"

IN-SWING WITH NARROW STYLE FIXED LITES  
1" & 1-1/2" INSULATED & 9/16" SINGLE  
GLAZING SHOWN

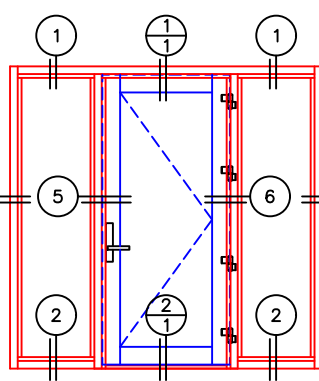
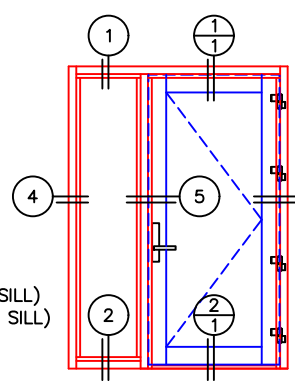
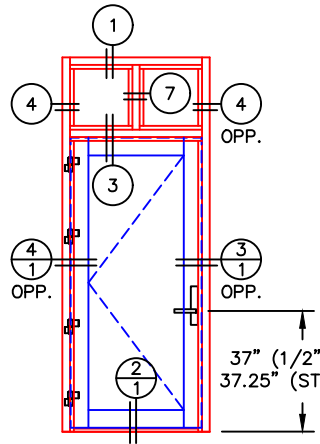
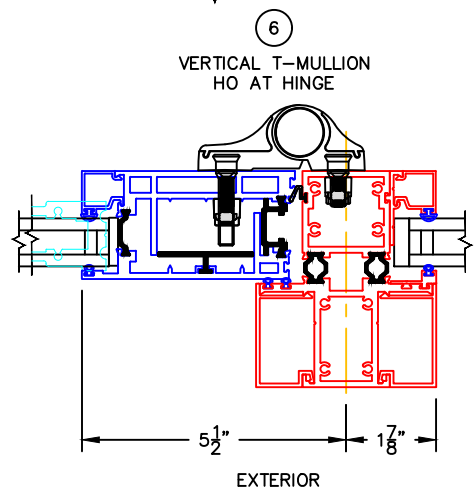
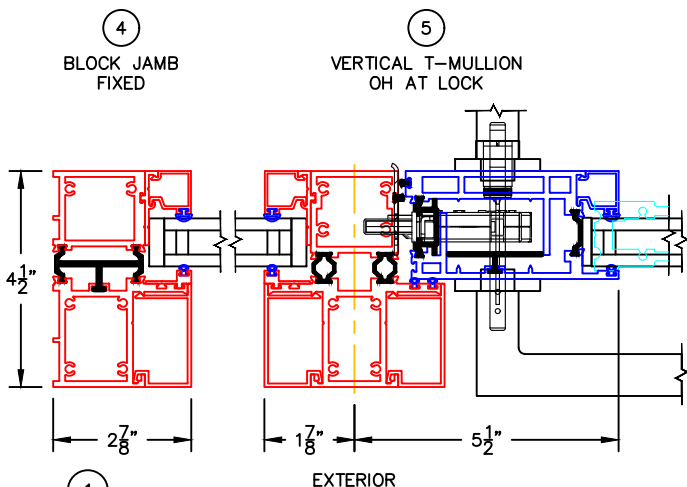
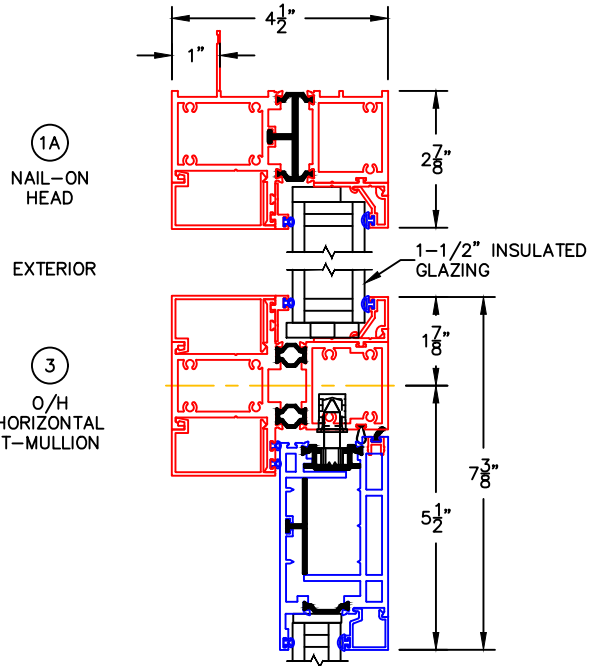
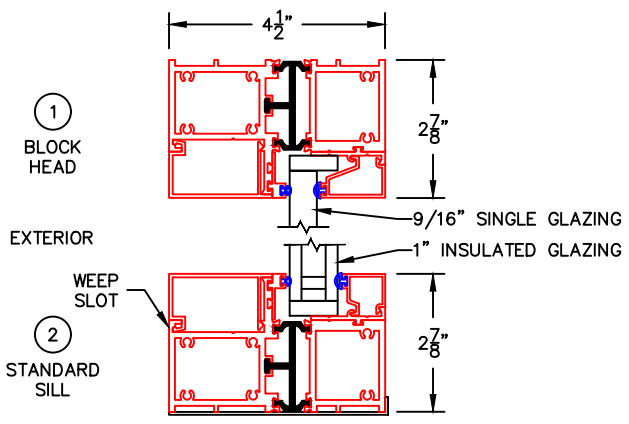

-GLASS PENETRATION: 9/16"  
-3/32" VENT FLUSH TOLERANCE IN CLOSED POSITION.  
-EXTERIOR RATED PRODUCTS HAVE WEEP SLOTS ON HORIZONTAL SILLS.

0 0.5 1  
(USE RULER TO SCALE DIMENSIONS IN INCHES)  
**SCALE: FULL**

IN-SWING NARROW STYLE FIXED LITE DETAIL  
1" INSULATED & 9/16" SINGLE  
GLAZING SHOWN

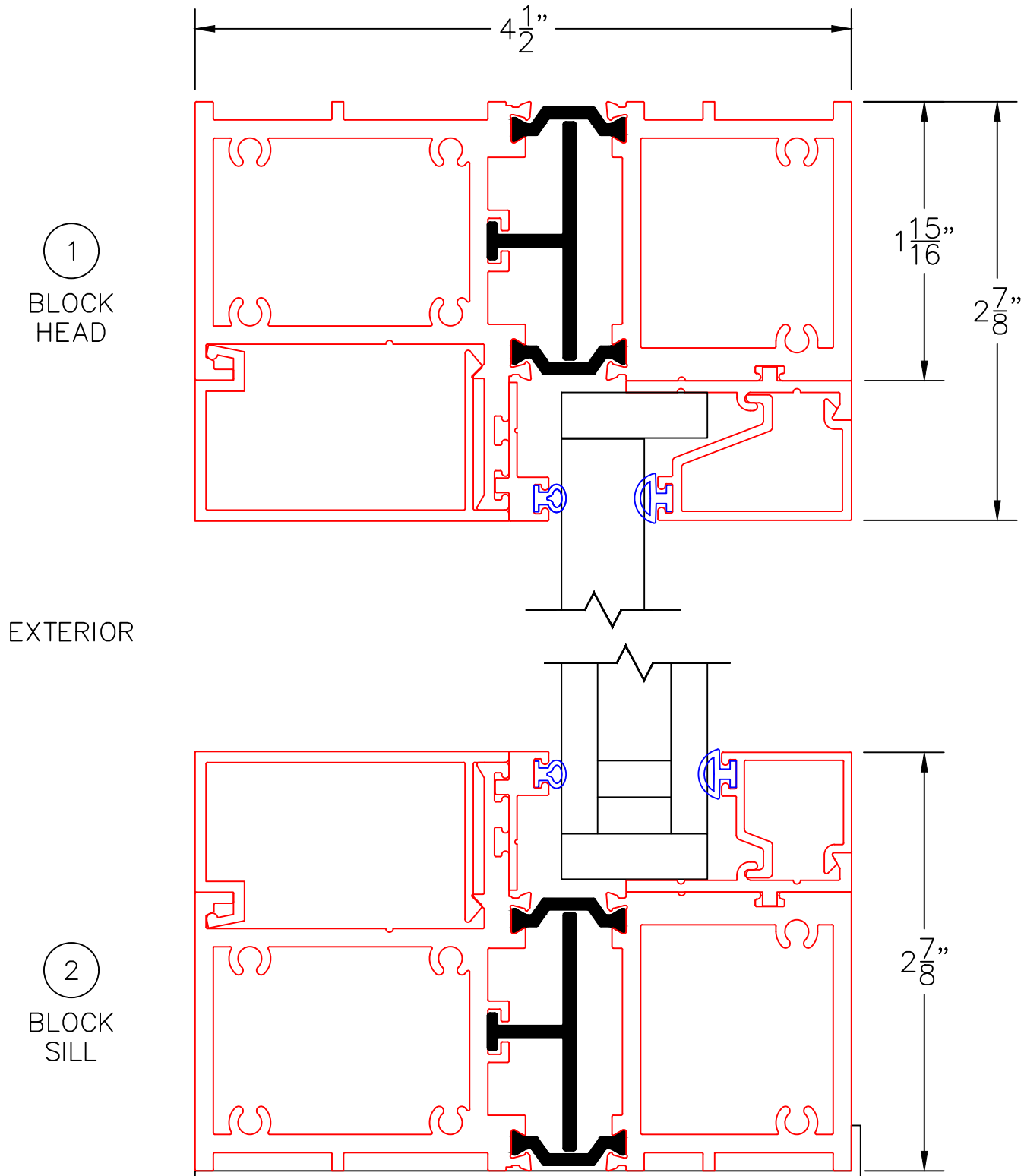

0 0.5 1  
 (USE RULER TO SCALE DIMENSIONS IN INCHES)  
**SCALE: FULL**

IN-SWING NARROW STYLE FIXED LITE DETAIL  
 1-1/2" INSULATED GLAZING SHOWN

1A  
 NAIL-ON  
 HEAD

EXTERIOR

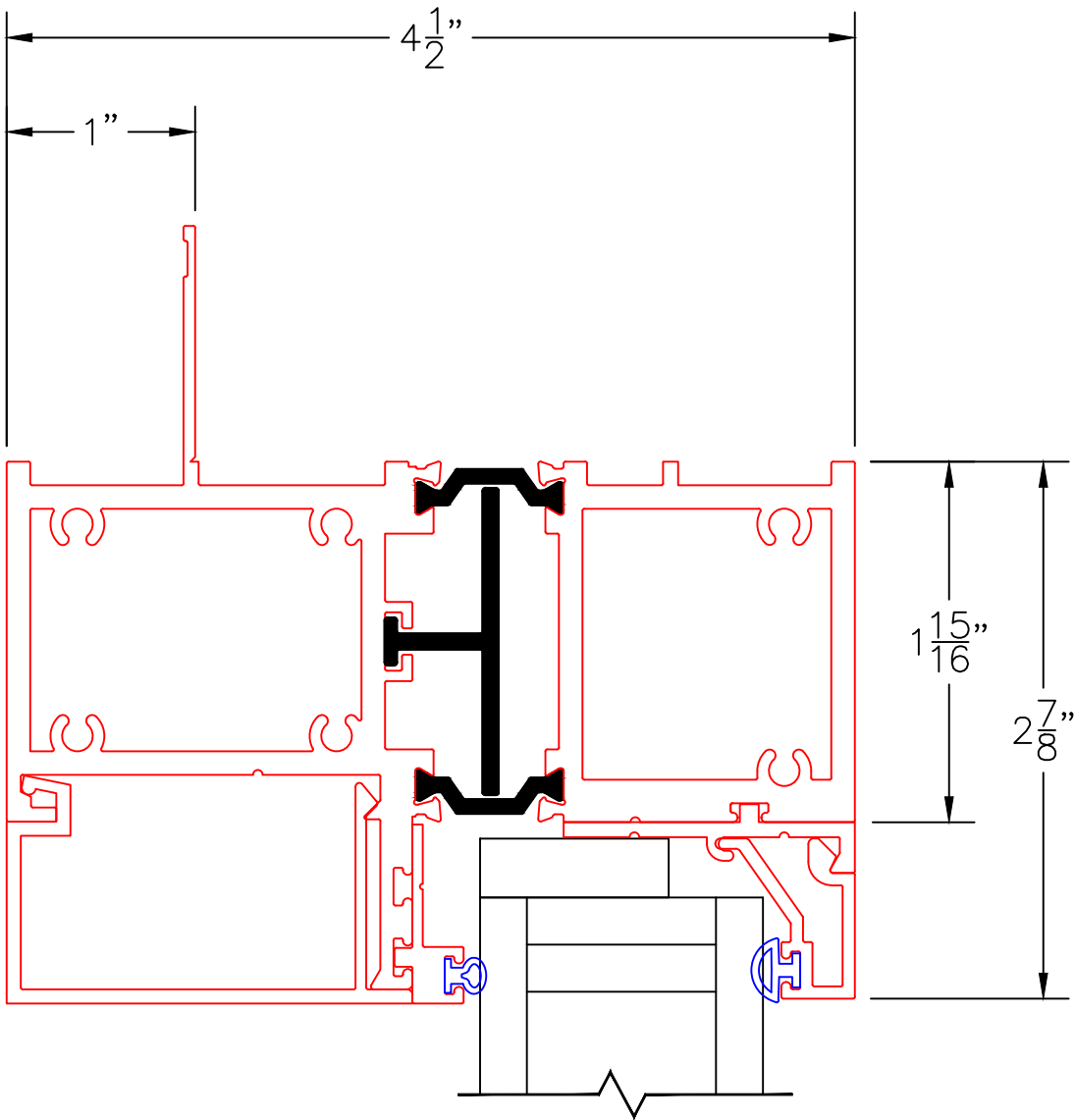

0 0.5 1  
(USE RULER TO SCALE DIMENSIONS IN INCHES)  
**SCALE: FULL**

IN-SWING NARROW STYLE FIXED LITE DETAIL  
1" & 1-1/2" INSULATED GLAZING SHOWN

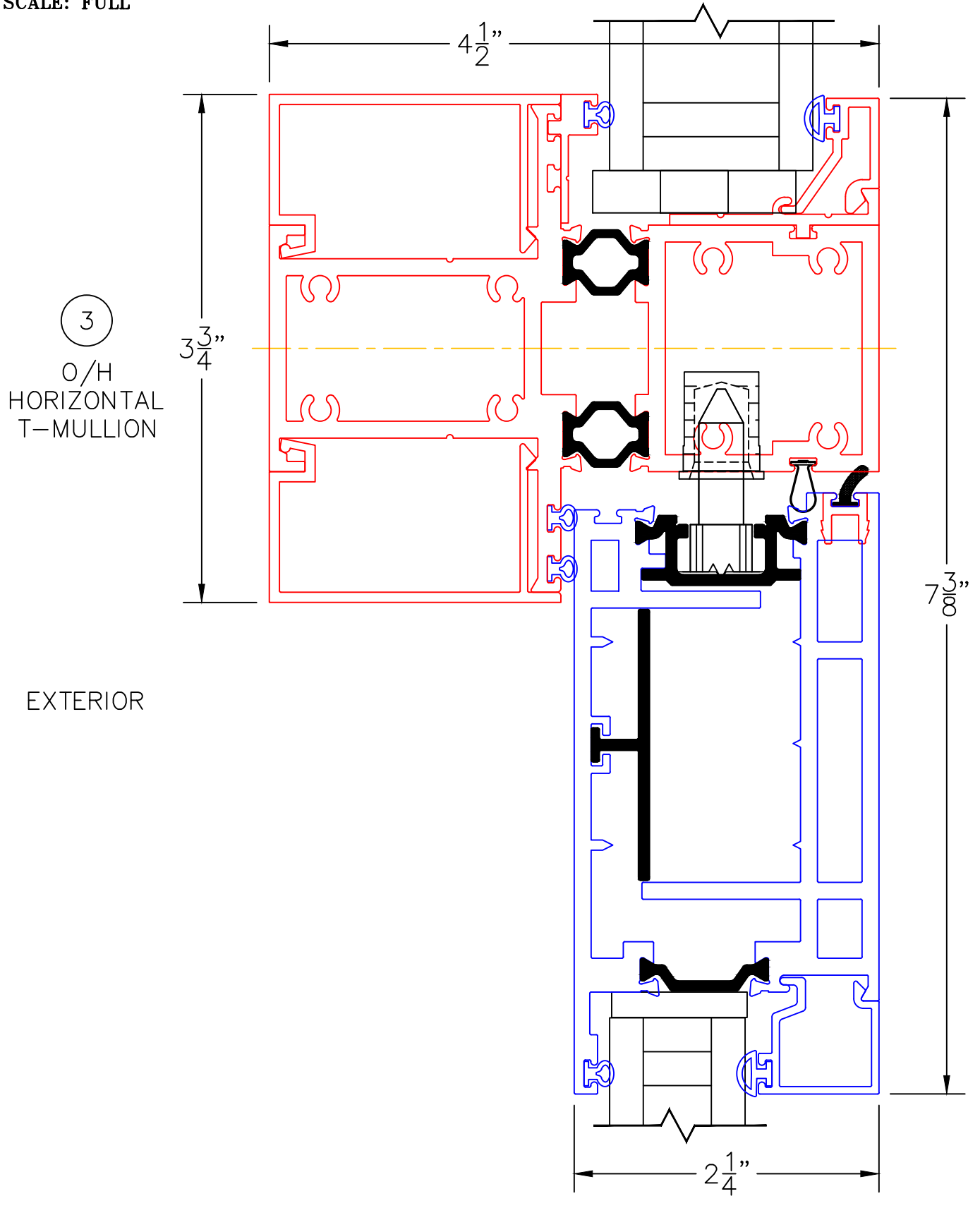

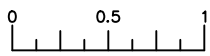

(USE RULER TO SCALE DIMENSIONS IN INCHES)

**SCALE: FULL**

IN-SWING NARROW STYLE FIXED LITE DETAIL  
1" INSULATED GLAZING SHOWN

4

FIXED  
JAMB

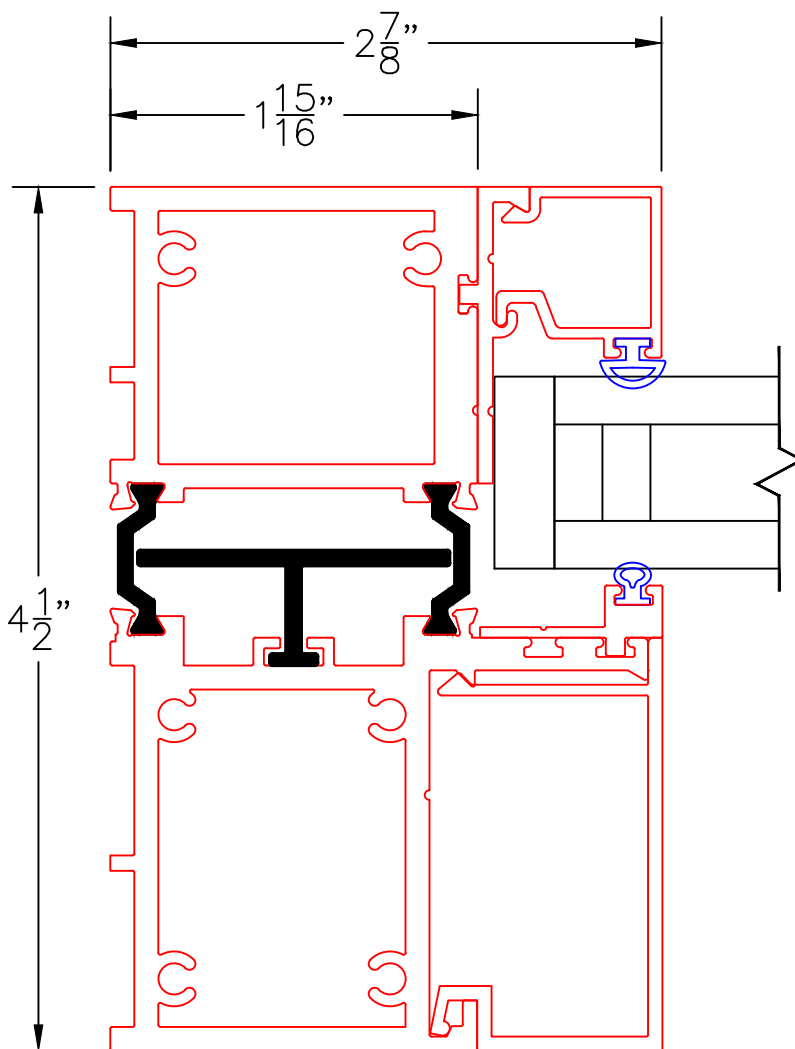

EXTERIOR

IN-SWING NARROW STYLE FIXED LITE DETAIL  
1" INSULATED GLAZING SHOWN

0 0.5 1  
(USE RULER TO SCALE DIMENSIONS IN INCHES)  
**SCALE: FULL**

5  
VERTICAL T-MULLION  
OH AT LOCK

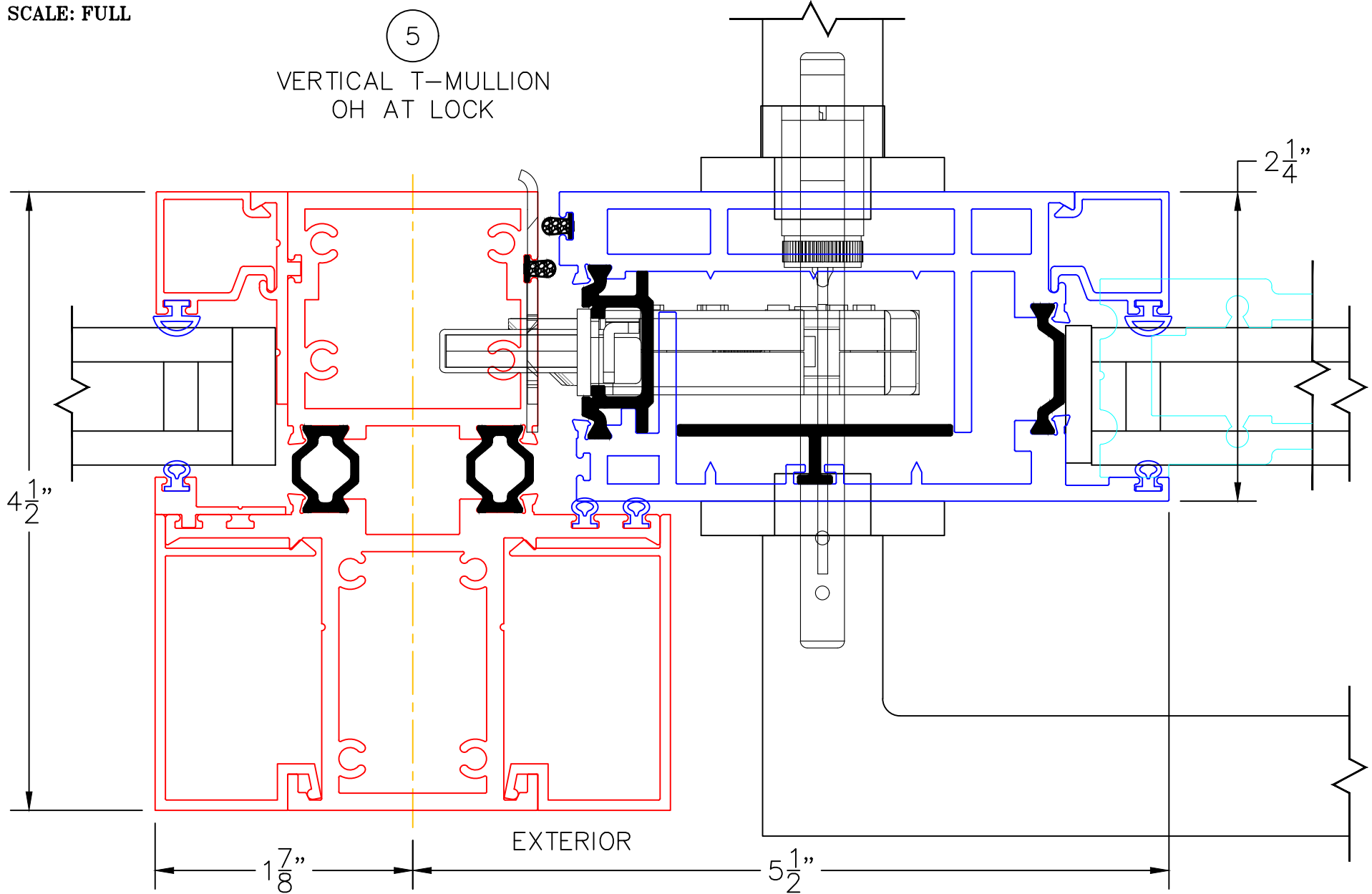

IN-SWING NARROW STYLE FIXED LITE DETAIL  
1" INSULATED GLAZING SHOWN

0 0.5 1  
(USE RULER TO SCALE DIMENSIONS IN INCHES)  
**SCALE: FULL**

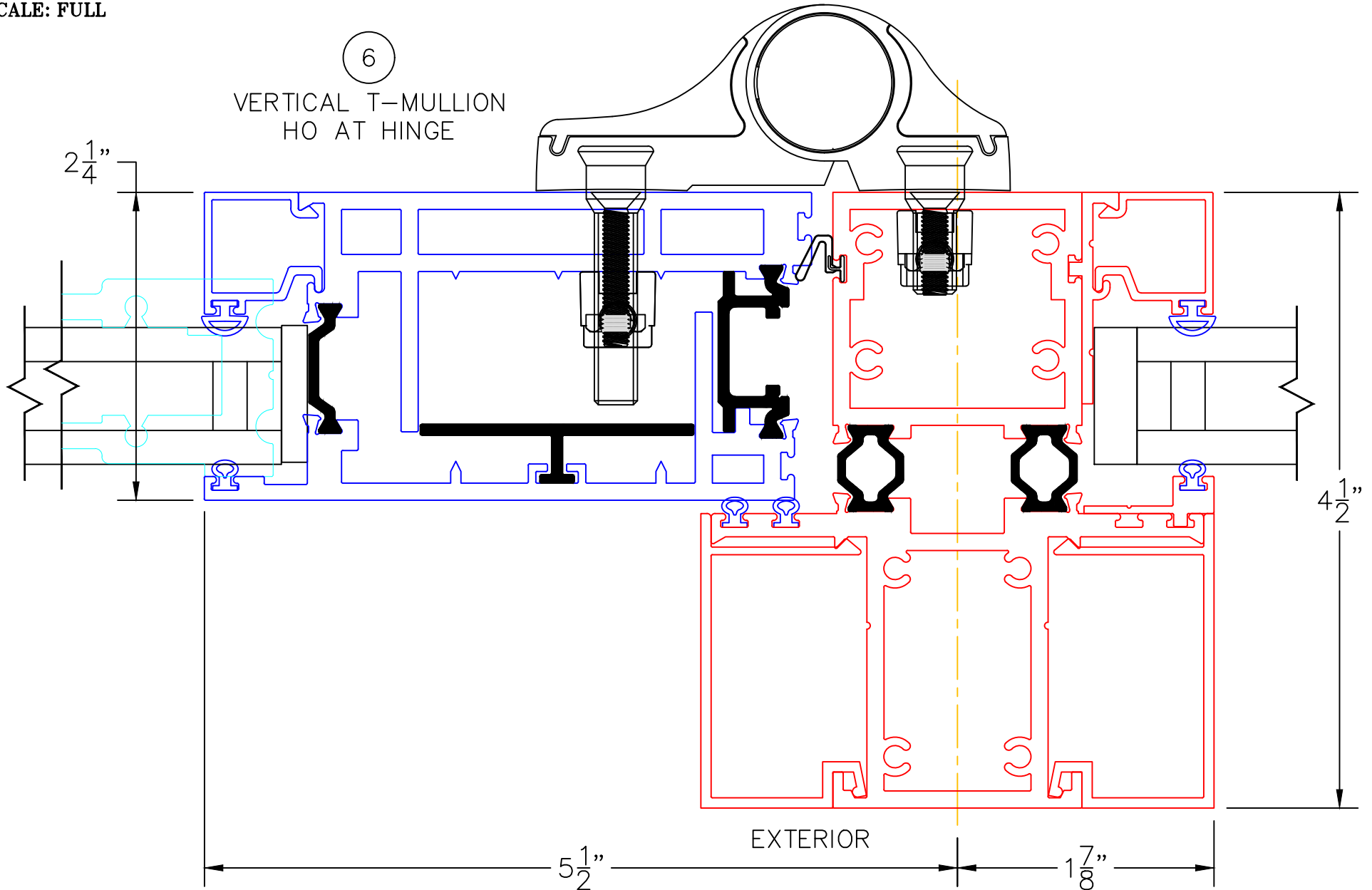

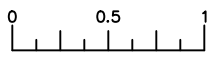

(USE RULER TO SCALE DIMENSIONS IN INCHES)

**SCALE: FULL**

IN-SWING NARROW STYLE FIXED LITE DETAIL  
1" INSULATED GLAZING SHOWN

7

00  
VERTICAL  
T-MULLION

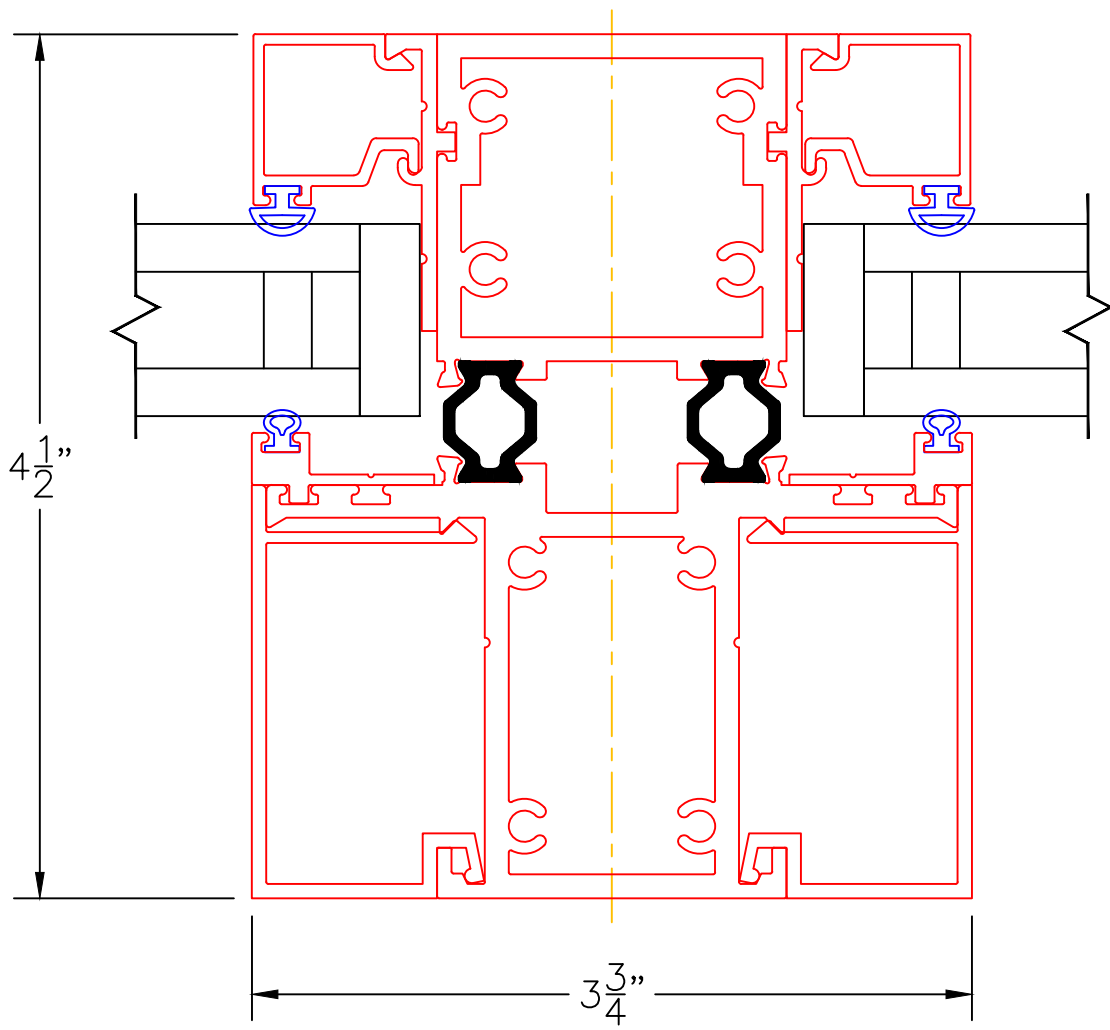

EXTERIOR