

(USE RULER TO SCALE DIMENSIONS IN INCHES)

SCALE: 1/4"

FOLDING IN-SWING DOOR DETAILS
1" & 1-1/2" INSULATED & 9/16" SINGLE
GLAZING SHOWN

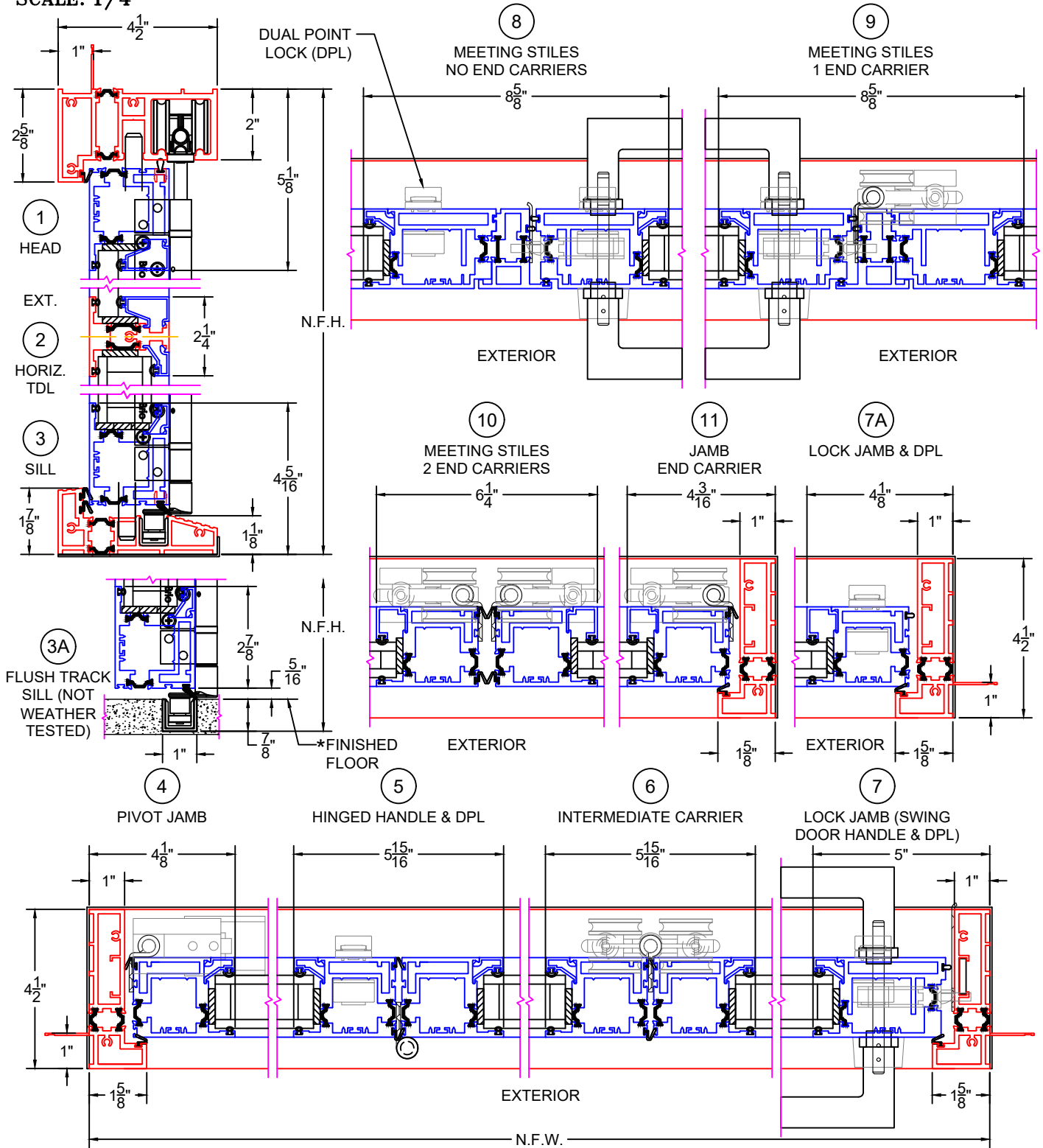

- REFERENCE PAGE 3600-T-003 FOR ELEVATIONS (SIMILAR).
- NAIL-FIN FRAME SHOWN, BLOCK FRAME AVAILABLE.
- GLASS PENETRATION = 9/16"
- EXTERIOR RATED PRODUCTS HAVE WEEP SLOTS ON HORIZONTAL SILLS.
- MEETING STILES WITH NO END CARRIERS: ACTIVE RIGHT SHOWN.
- *JAMBS TO THE FINISHED FLOOR HEIGHT (FINISHED FLOOR BY OTHERS).

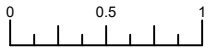

(USE RULER TO SCALE DIMENSIONS IN INCHES)

SCALE: FULL

FOLDING IN-SWING DOOR DETAILS
9/16" SINGLE GLAZING SHOWN

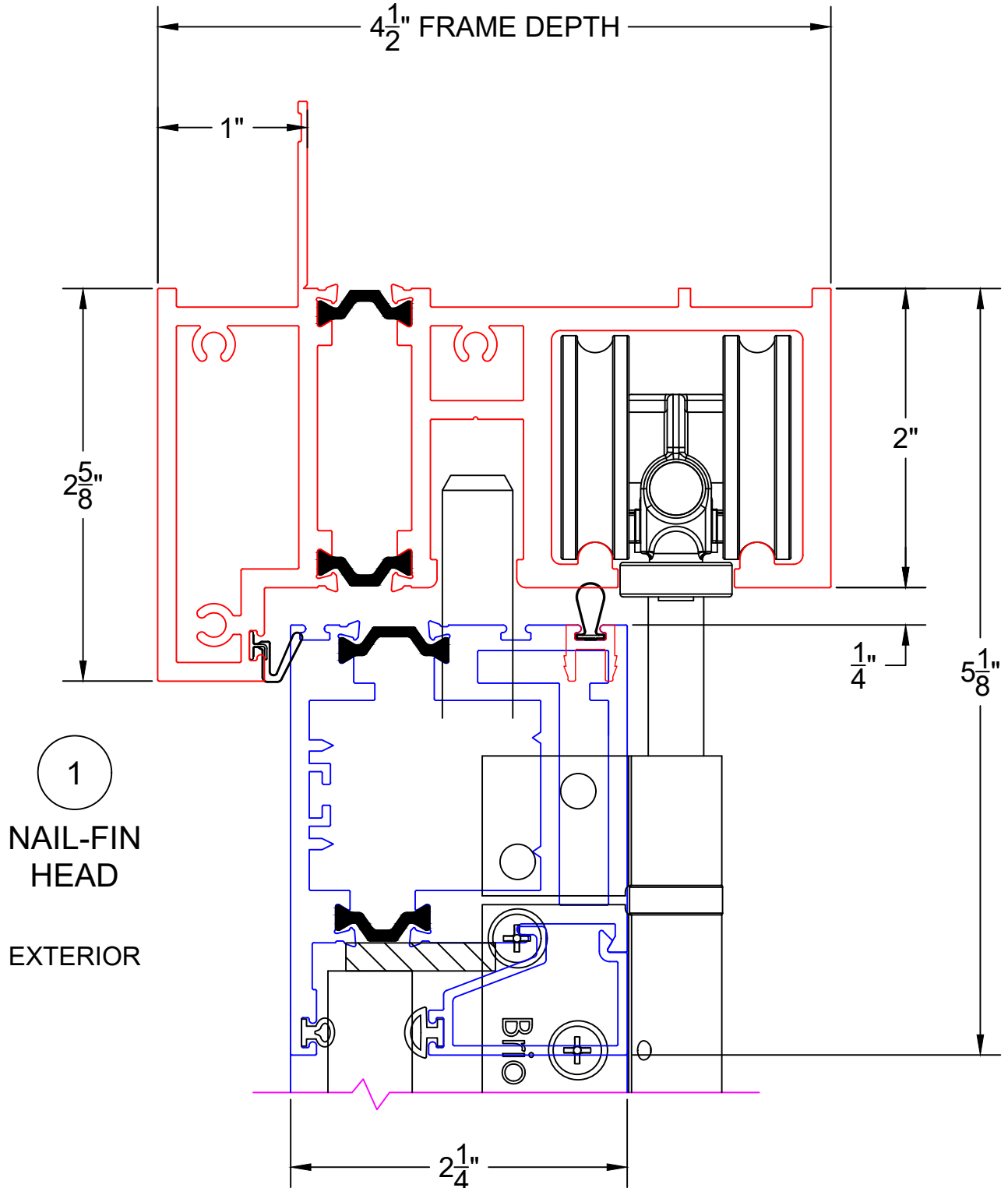

0 0.5 1
(USE RULER TO SCALE DIMENSIONS IN INCHES)
SCALE: FULL

FOLDING IN-SWING DOOR DETAILS
1-1/2" INSULATED AND 9/16" SINGLE
GLAZING SHOWN

②
HORIZONTAL
TDL BAR

EXTERIOR

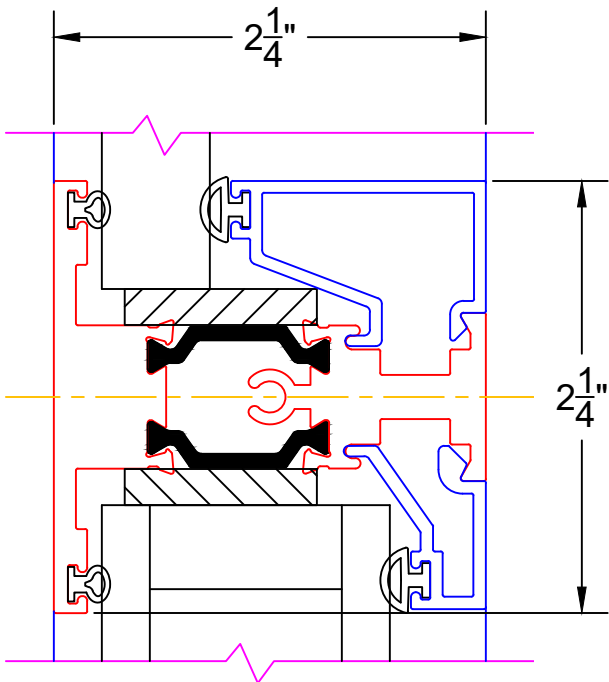

0 0.5 1
(USE RULER TO SCALE DIMENSIONS IN INCHES)
SCALE: FULL

FOLDING IN-SWING DOOR DETAILS
1-1/2" INSULATED GLAZING SHOWN

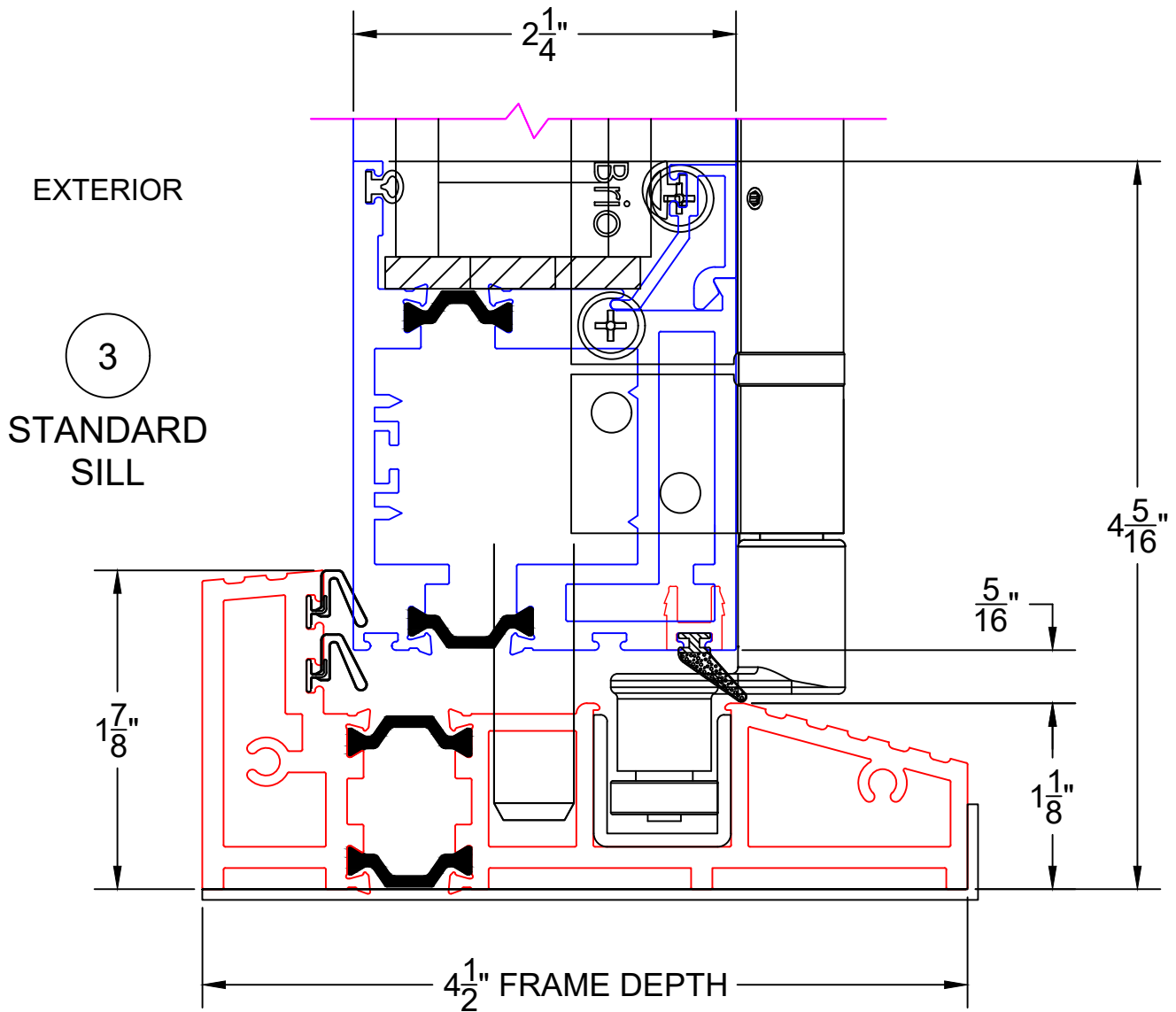

0 0.5 1
 (USE RULER TO SCALE DIMENSIONS IN INCHES)
SCALE: FULL

FOLDING IN-SWING DOOR DETAILS
1-1/2" INSULATED GLAZING SHOWN

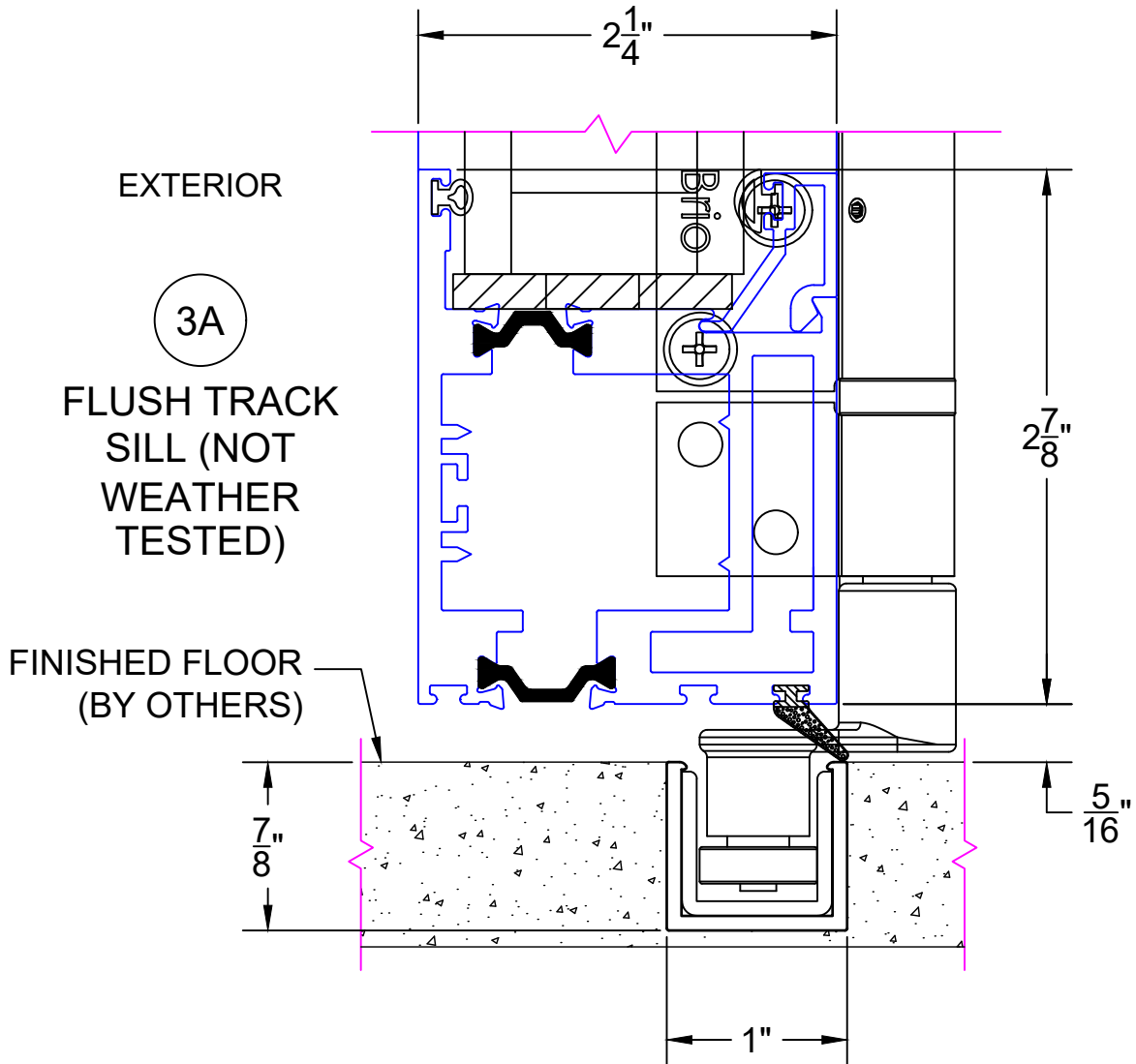

0 0.5 1
 (USE RULER TO SCALE DIMENSIONS IN INCHES)
SCALE: FULL

FOLDING IN-SWING DOOR DETAILS
1-1/2" INSULATED GLAZING SHOWN

4

**PIVOT
JAMB**

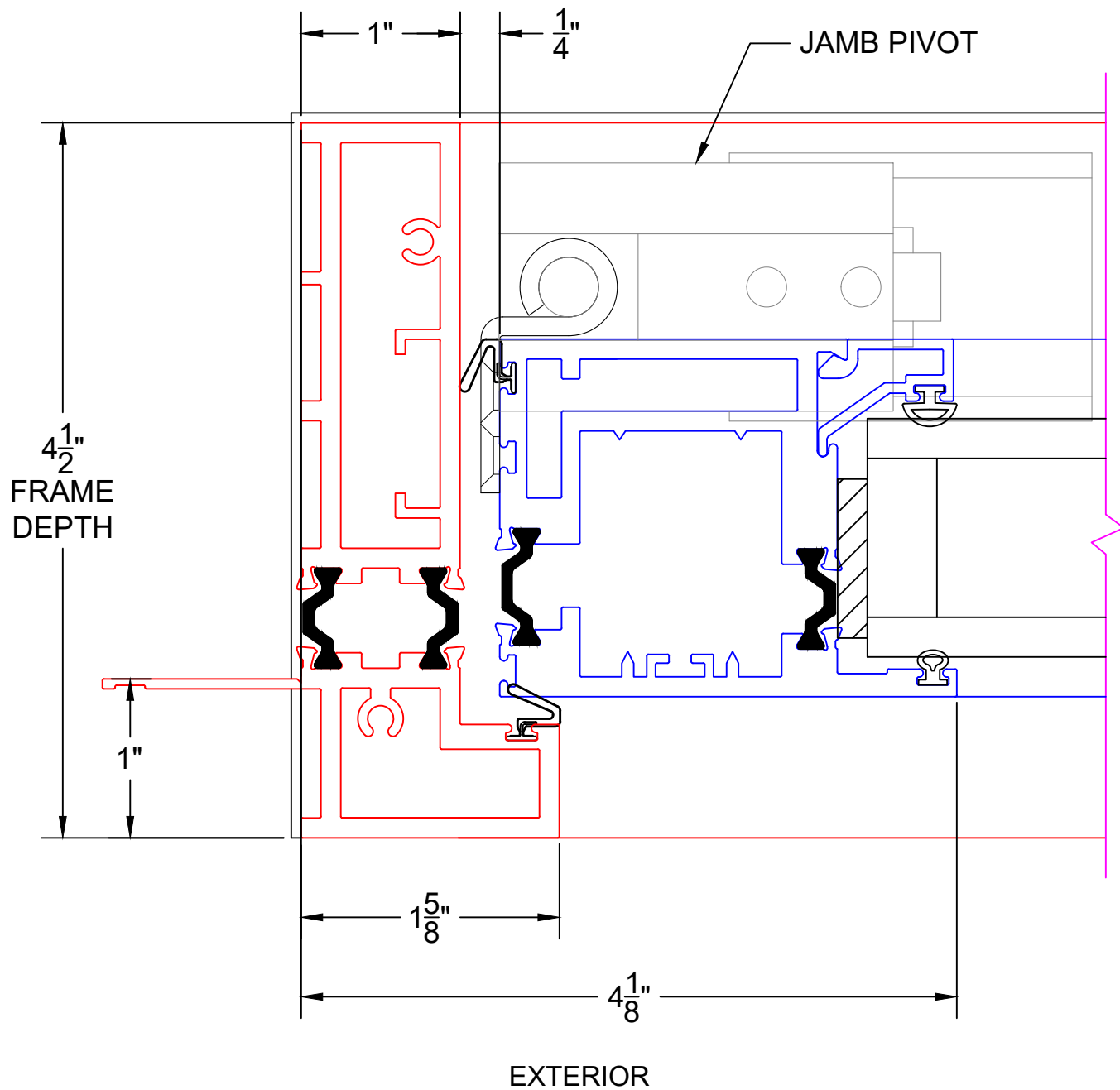

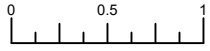

(USE RULER TO SCALE DIMENSIONS IN INCHES)

SCALE: FULL

5

FOLDING IN-SWING DOOR DETAILS 1-1/2" INSULATED GLAZING SHOWN

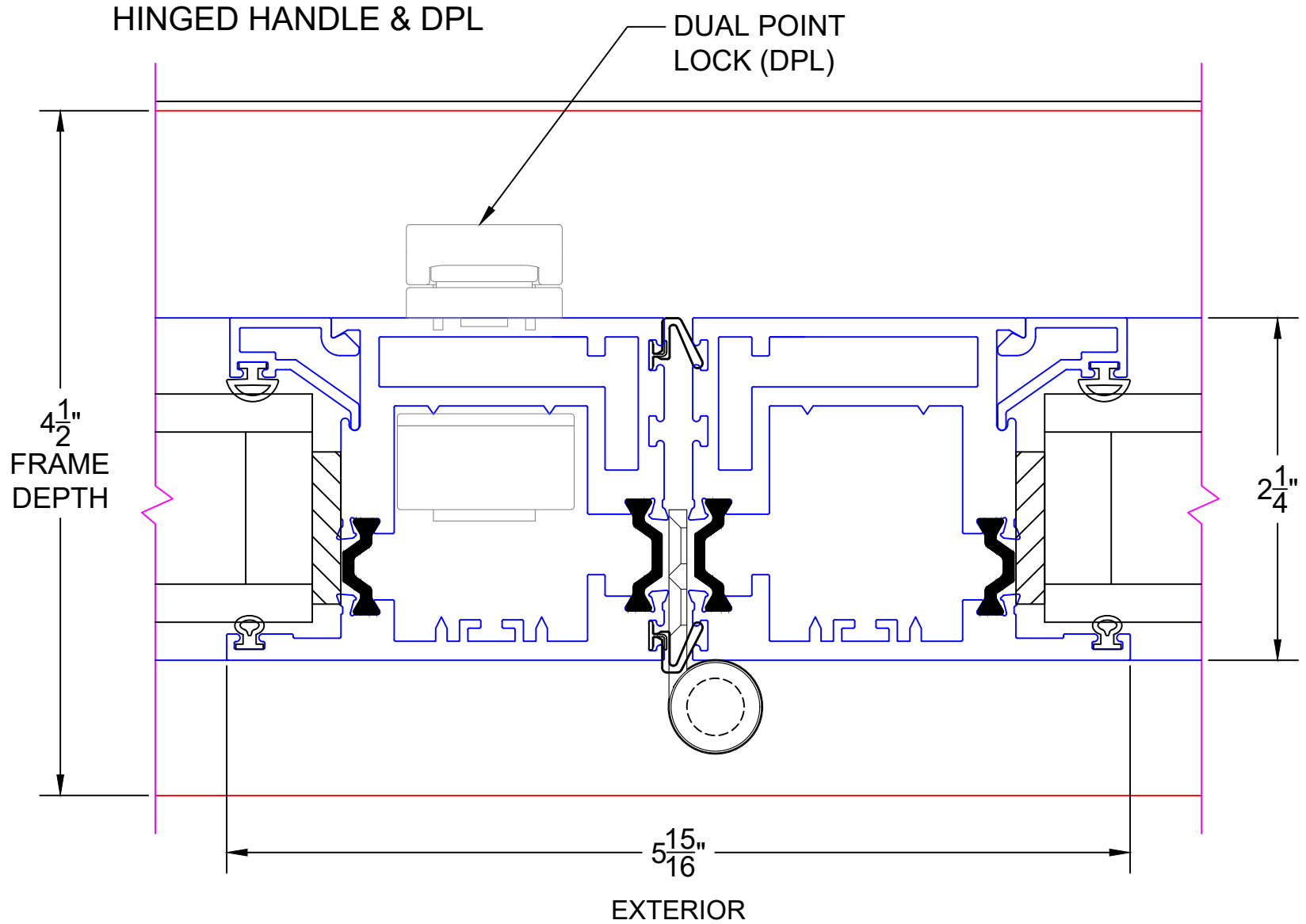

FOLDING IN-SWING DOOR DETAILS
1-1/2" INSULATED GLAZING SHOWN

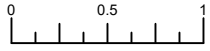

(USE RULER TO SCALE DIMENSIONS IN INCHES)

SCALE: FULL

6

INTERMEDIATE CARRIER

INTERMEDIATE CARRIER

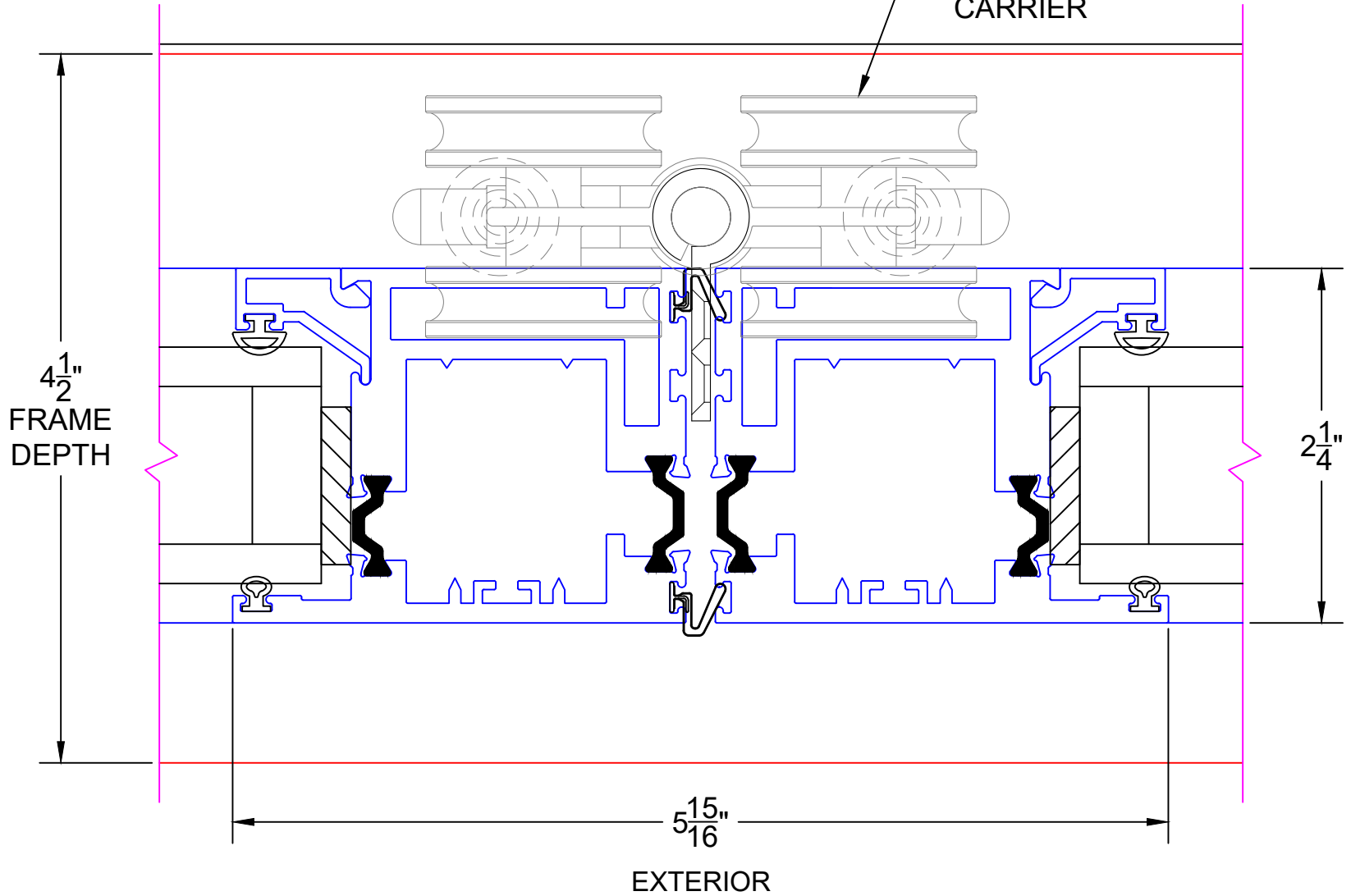

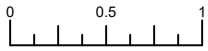

(USE RULER TO SCALE DIMENSIONS IN INCHES)

SCALE: FULL

FOLDING IN-SWING DOOR DETAILS
1-1/2" INSULATED GLAZING SHOWN

7

LOCK JAMB (SWING
DOOR HANDLE & DPL)

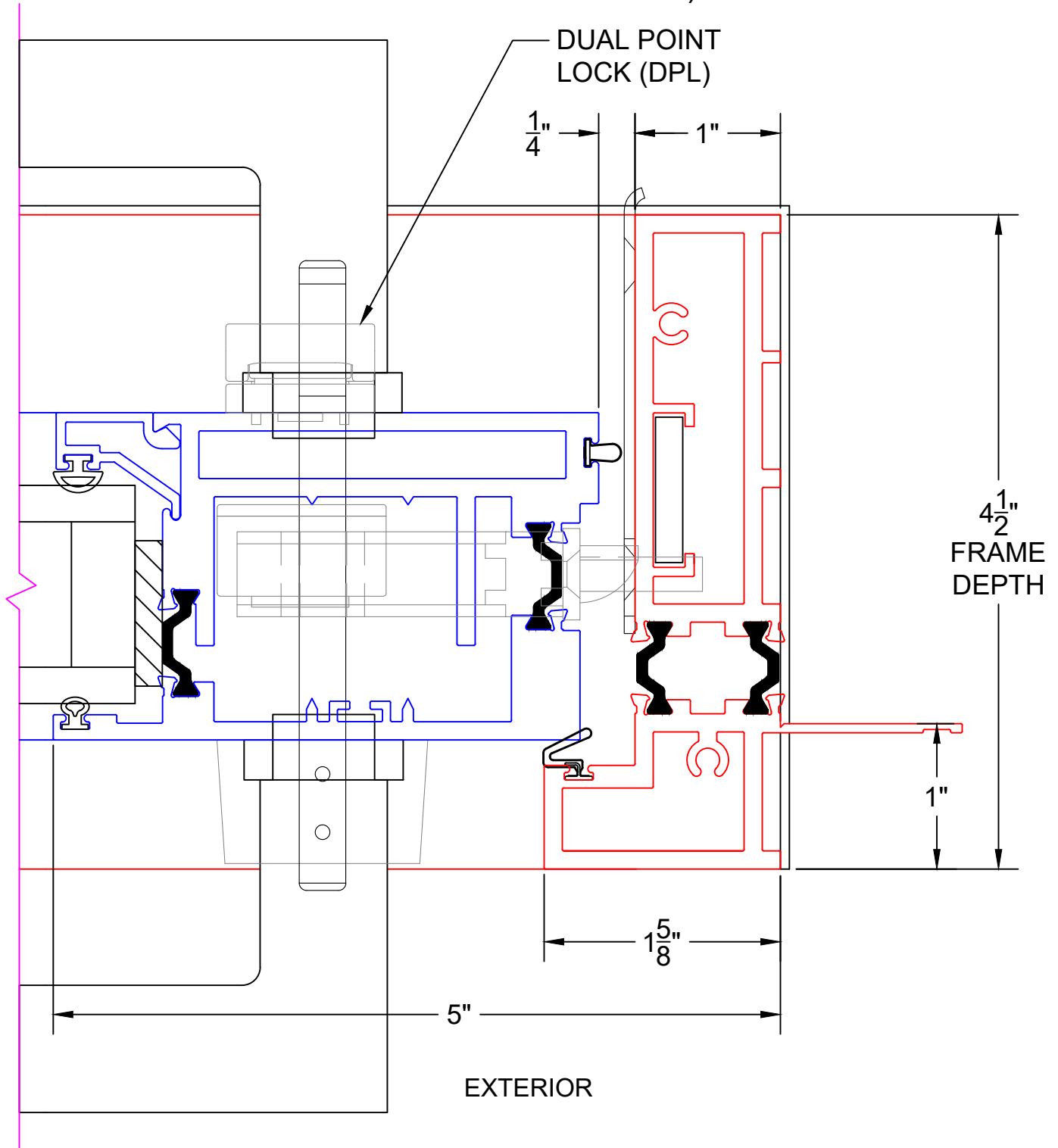

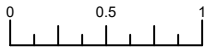

(USE RULER TO SCALE DIMENSIONS IN INCHES)

SCALE: FULL

FOLDING IN-SWING DOOR DETAILS
1" INSULATED GLAZING SHOWN

7A

LOCK JAMB & DPL

DUAL POINT
LOCK (DPL)

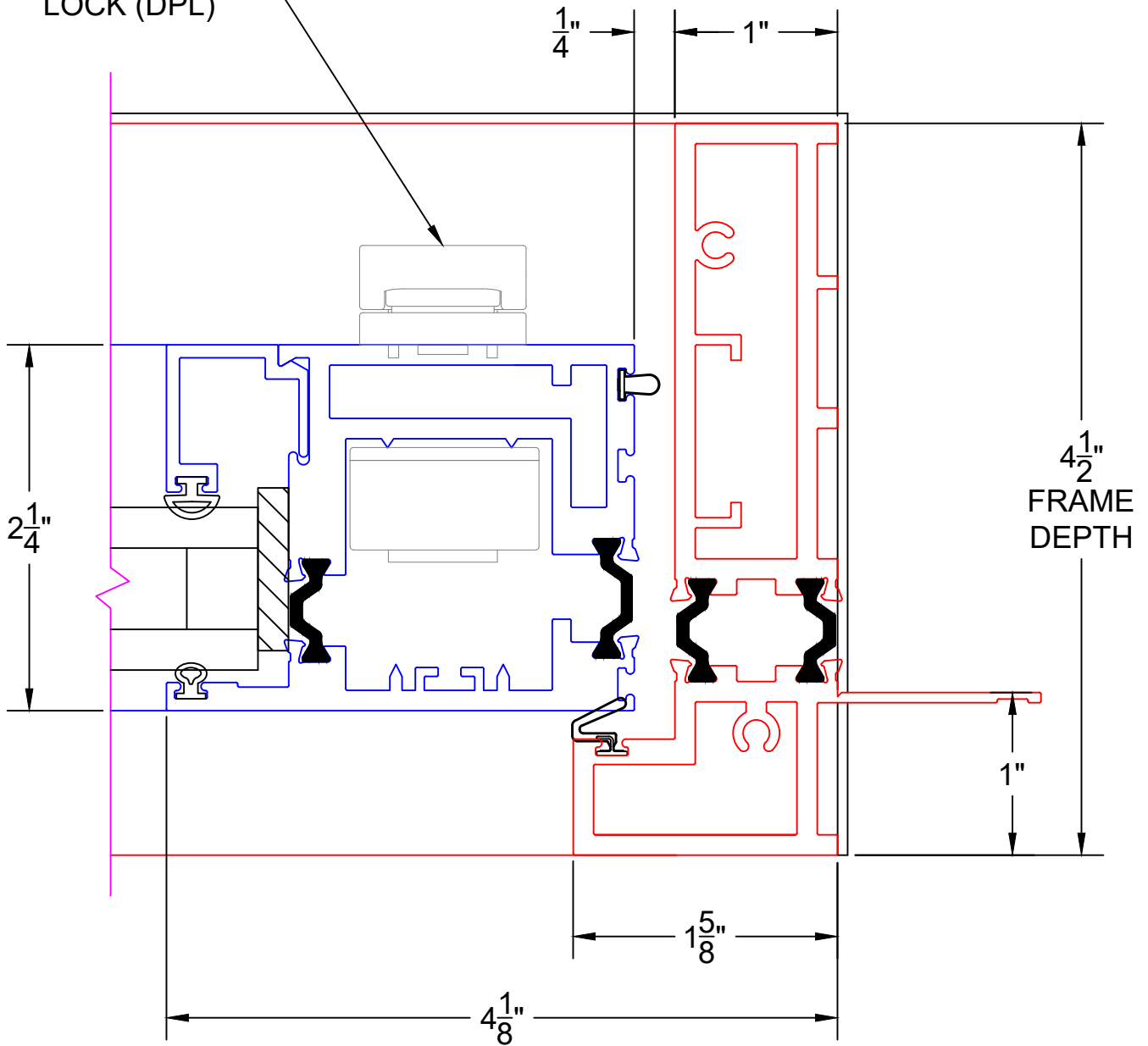

EXTERIOR

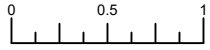

(USE RULER TO SCALE DIMENSIONS IN INCHES)

SCALE: FULL

8

FOLDING IN-SWING DOOR DETAILS 1-1/2" INSULATED GLAZING SHOWN

MEETING STILES
NO END CARRIERS

DUAL POINT LOCK
(DPL) (2PLCS)

4 1/2"
FRAME
DEPTH

2 1/4"

8 5/8"

EXTERIOR

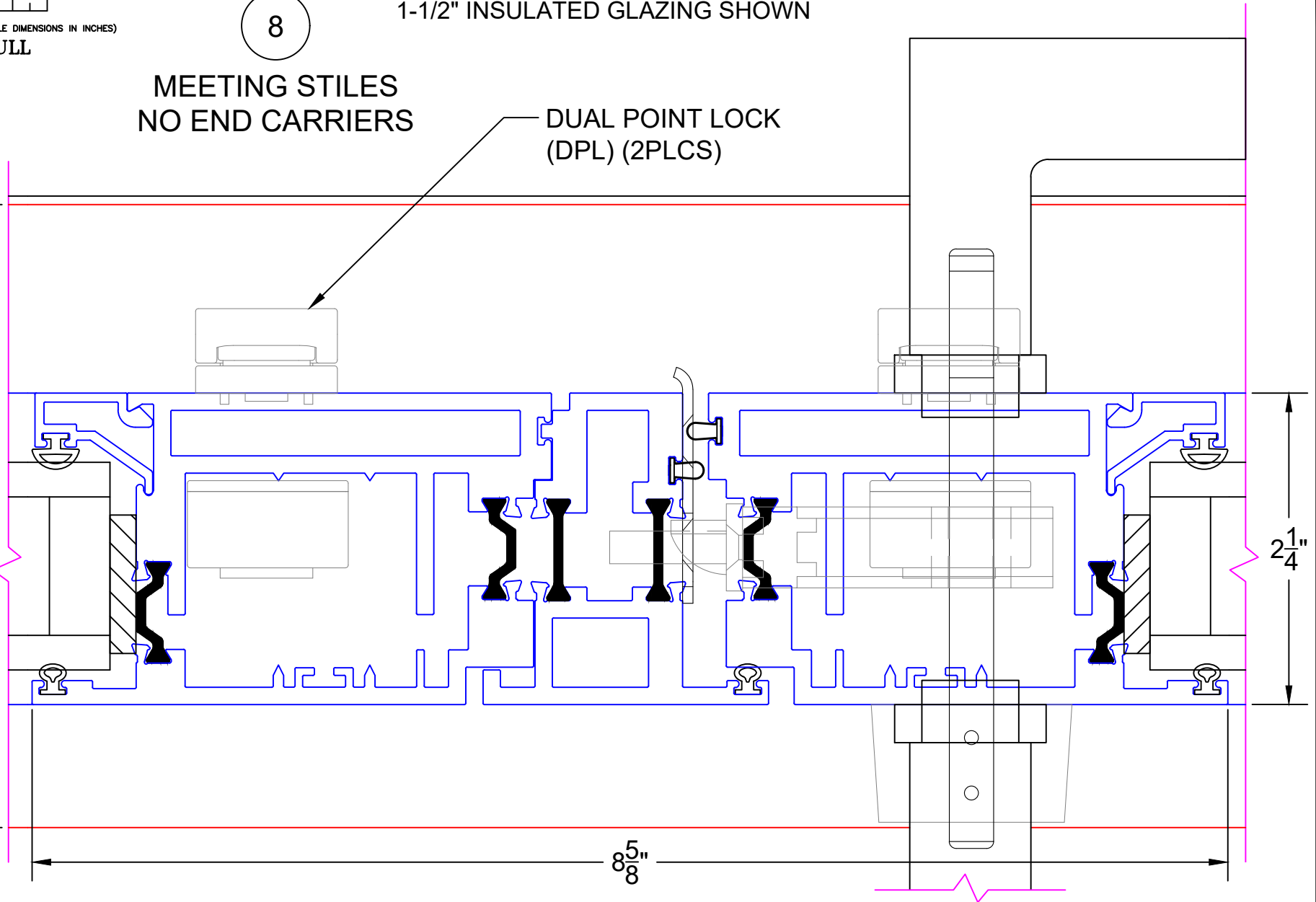

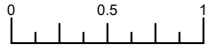

(USE RULER TO SCALE DIMENSIONS IN INCHES)
SCALE: FULL

9

FOLDING IN-SWING DOOR DETAILS 1-1/2" INSULATED GLAZING SHOWN

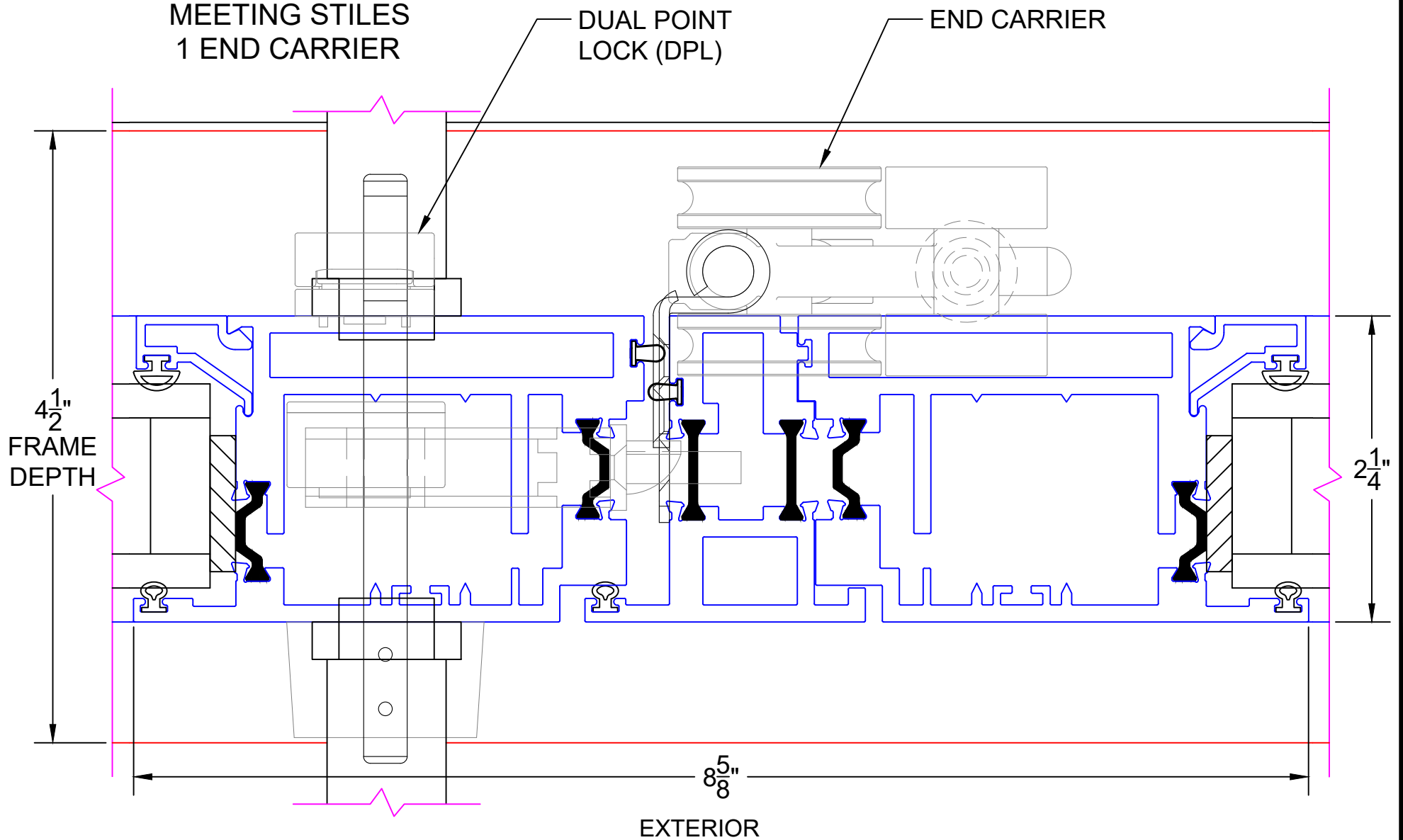

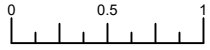

(USE RULER TO SCALE DIMENSIONS IN INCHES)

SCALE: FULL

10

FOLDING IN-SWING DOOR DETAILS 1" INSULATED GLAZING SHOWN

MEETING STILES
2 END CARRIERS

END CARRIER

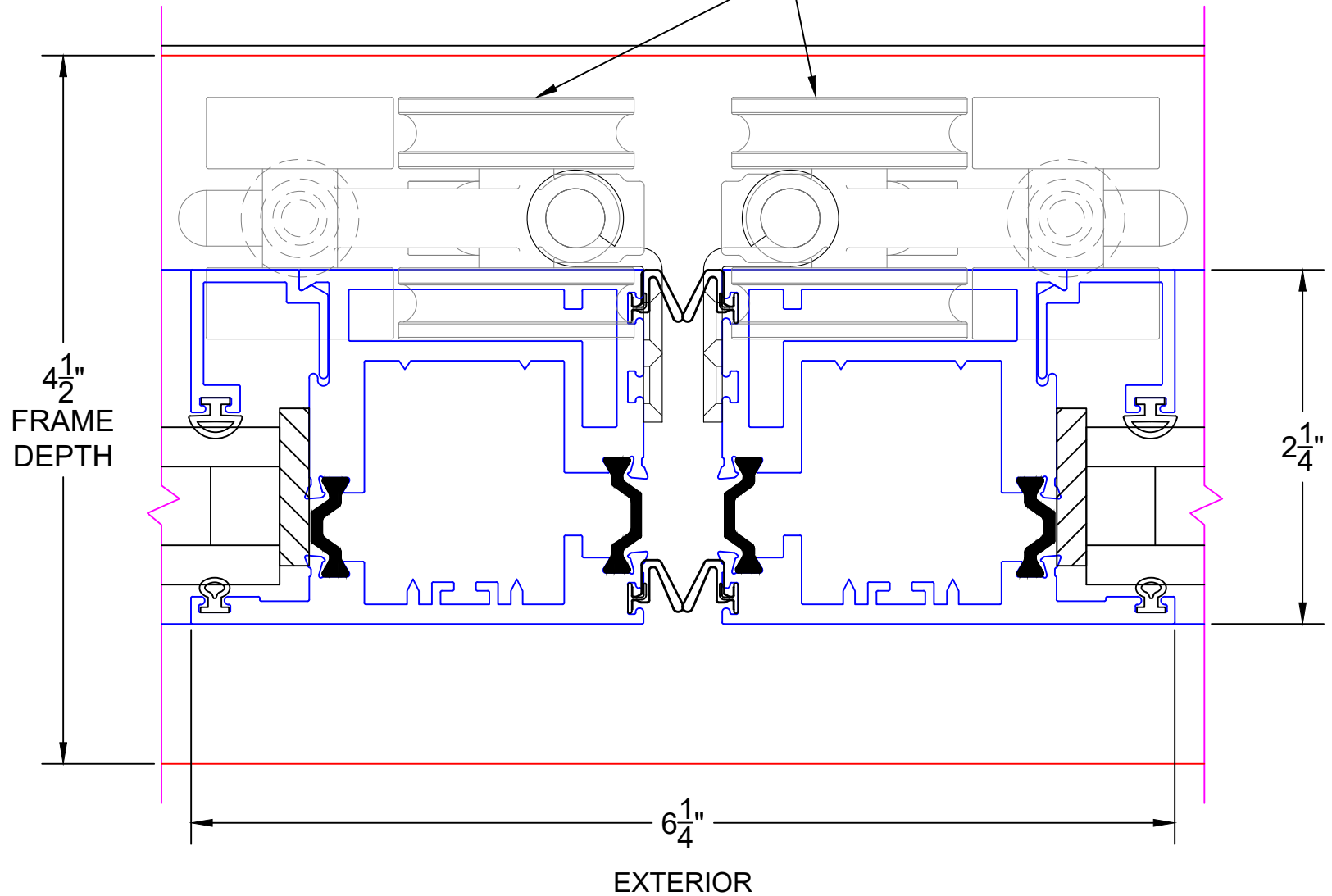

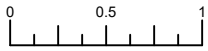

(USE RULER TO SCALE DIMENSIONS IN INCHES)

SCALE: FULL

FOLDING IN-SWING DOOR DETAILS
1" INSULATED GLAZING SHOWN

11

JAMB
END CARRIER

