



OPTIONS AND UPGRADES

(USE RULER TO SCALE DIMENSIONS IN INCHES)
SCALE: 1/4

①

ARCHETYPE
MEETING STILES

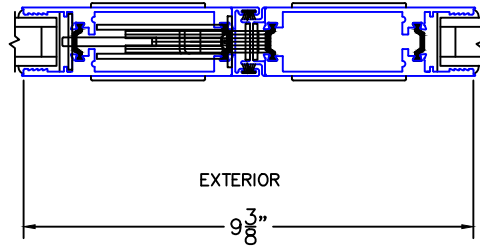

②

ARCHETYPE
LOCK JAMB

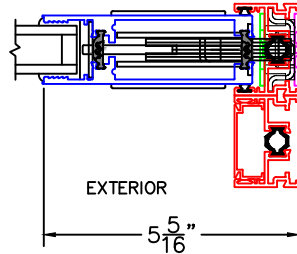

①A

HP1-T ARCHETYPE
MEETING STILES

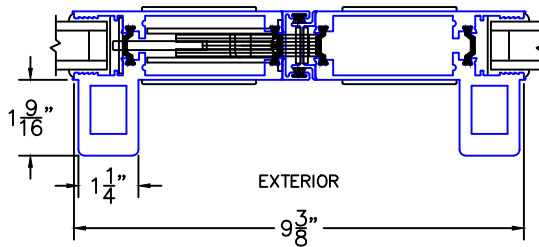

②A

HP1-T ARCHETYPE
LOCK STILE

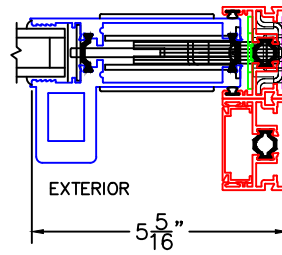

①B

HP2-T ARCHETYPE NARROW
MEETING STILES

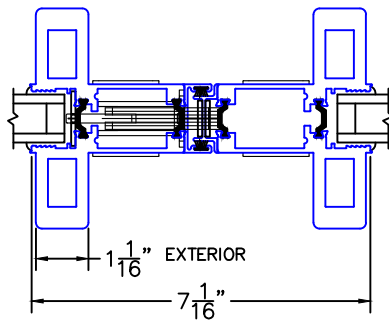

②B

*HP2-T ARCHETYPE
NARROW LOCK STILE

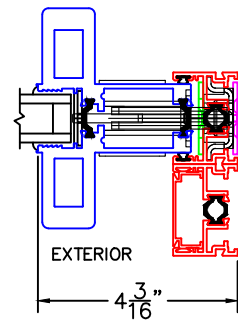

①C

HP1-T ARCHETYPE NARROW
MEETING STILES

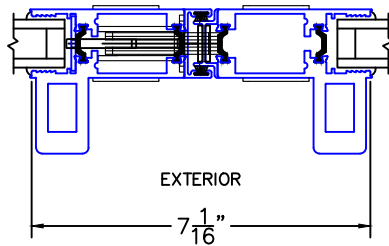

②C

**HP1-T ARCHETYPE
NARROW LOCK STILE

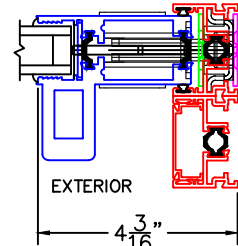

- NOTES:
 -*HP2-T ARCHETYPE NARROW LOCK JAMB: NO KEYED CYLINDER.
 -**HP1-T ARCHETYPE NARROW LOCK JAMB: KEYED CYLINDER OPPOSITE HP ONLY.
 -GLASS PENETRATION: 11/16"

OPTIONS AND UPGRADES

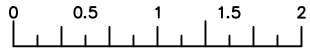

(USE RULER TO SCALE DIMENSIONS IN INCHES)

SCALE: 3/4

1

ARCHETYPE MEETING STILES

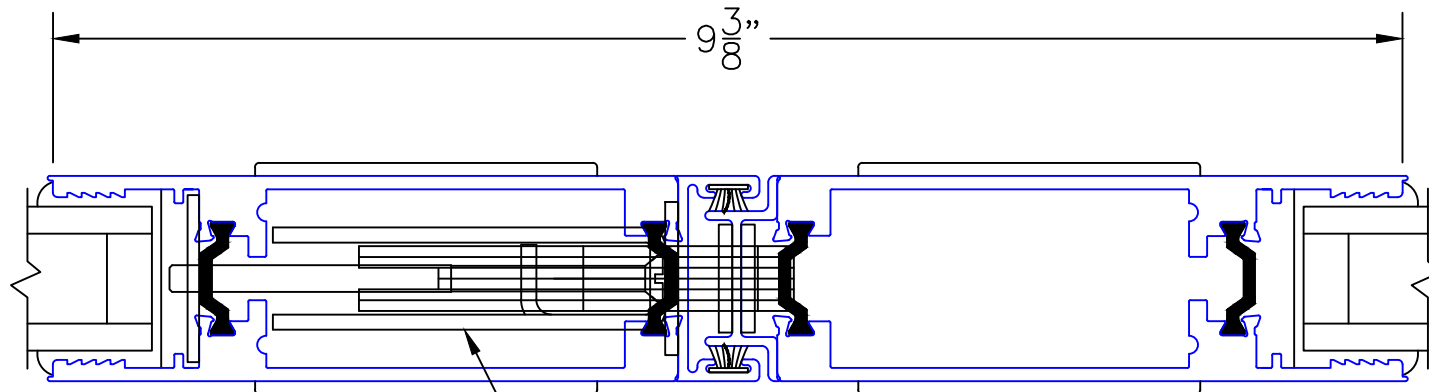

ARCHETYPE LATCH WITH
FLUSH PULL HANDLES

EXTERIOR

OPTIONS AND UPGRADES

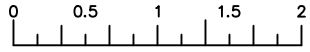

(USE RULER TO SCALE DIMENSIONS IN INCHES)

SCALE: 3/4

1A

HP1-T ARCHETYPE MEETING STILES

ARCHETYPE LATCH WITH
FLUSH PULL HANDLE

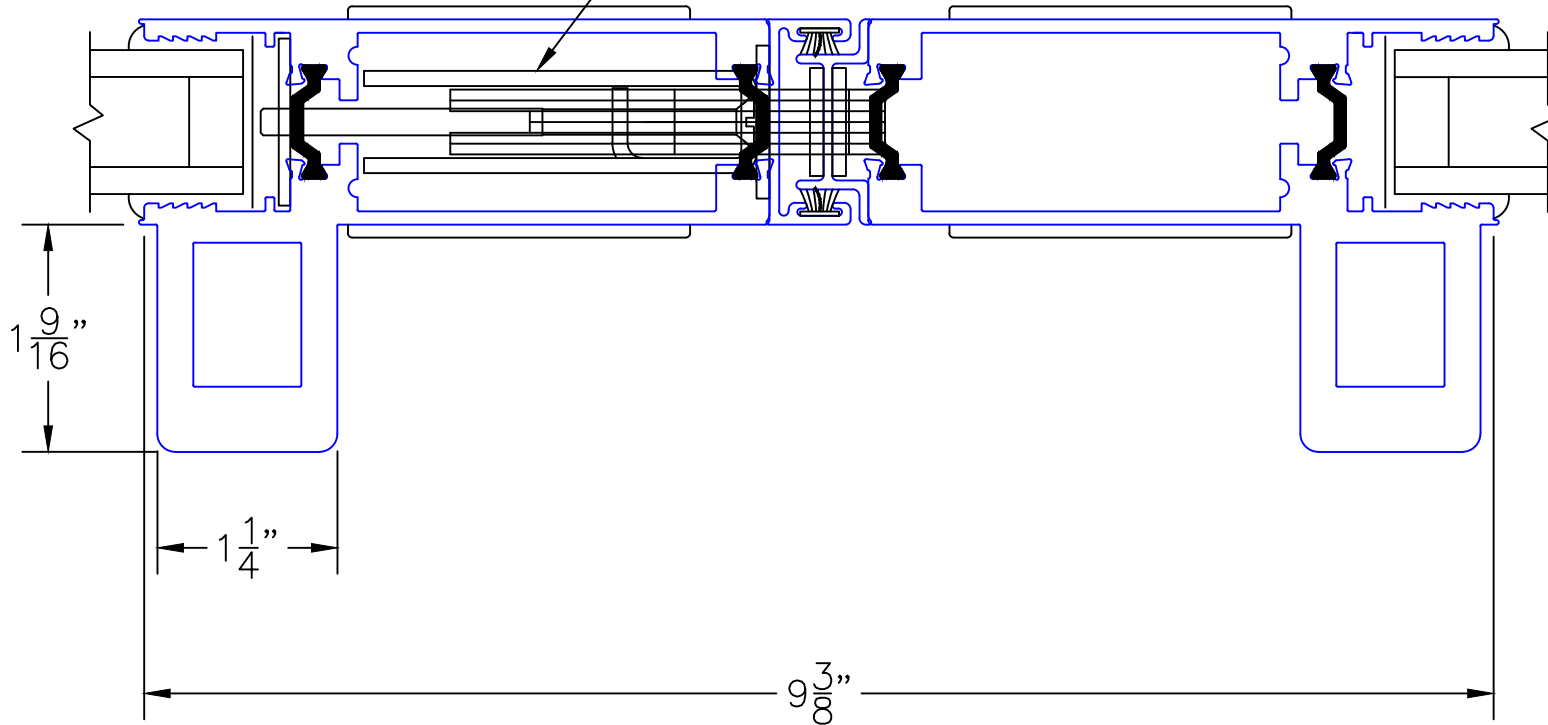

EXTERIOR

OPTIONS AND UPGRADES

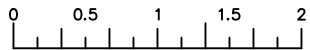

(USE RULER TO SCALE DIMENSIONS IN INCHES)

SCALE: 3/4

1B

HP2-T ARCHETYPE NARROW MEETING STILES

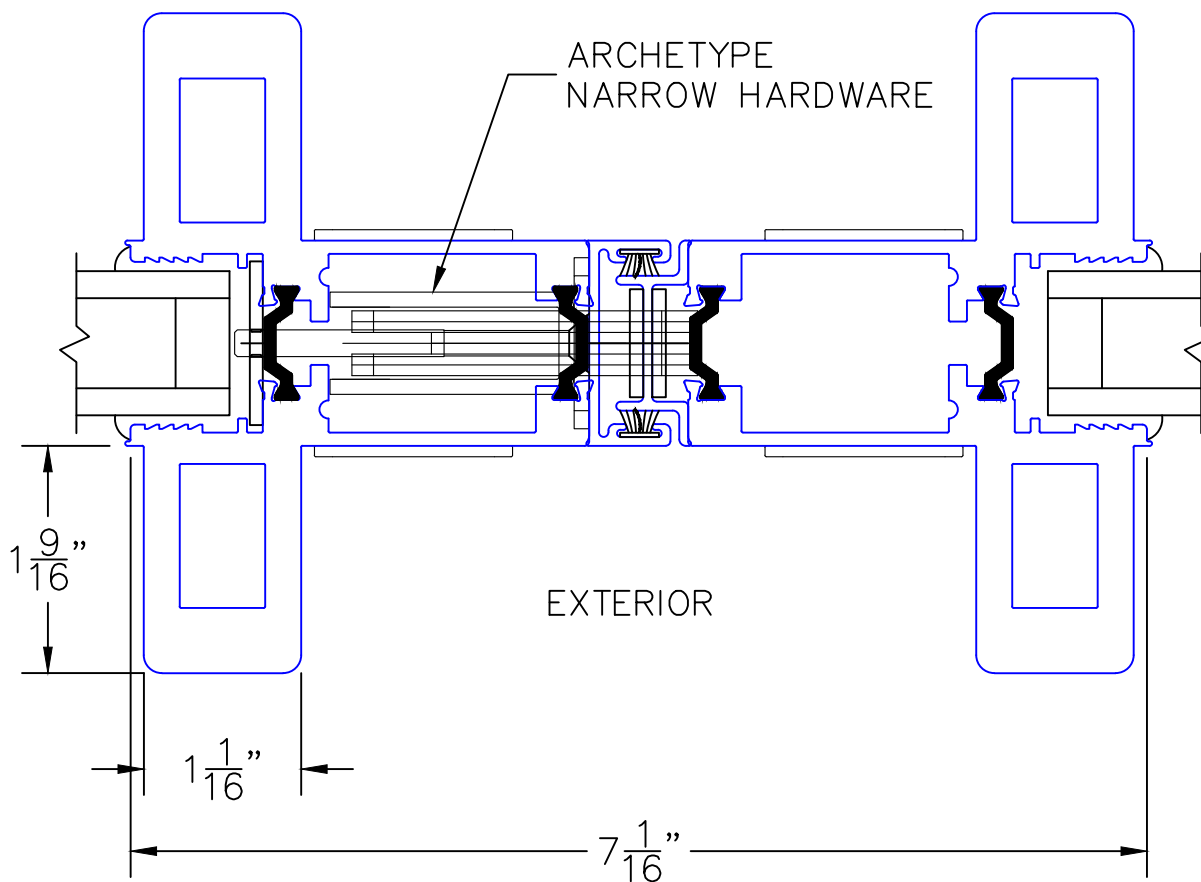

OPTIONS AND UPGRADES

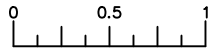

(USE RULER TO SCALE DIMENSIONS IN INCHES)

SCALE: FULL

1C

HP1-T ARCHETYPE NARROW MEETING STILES

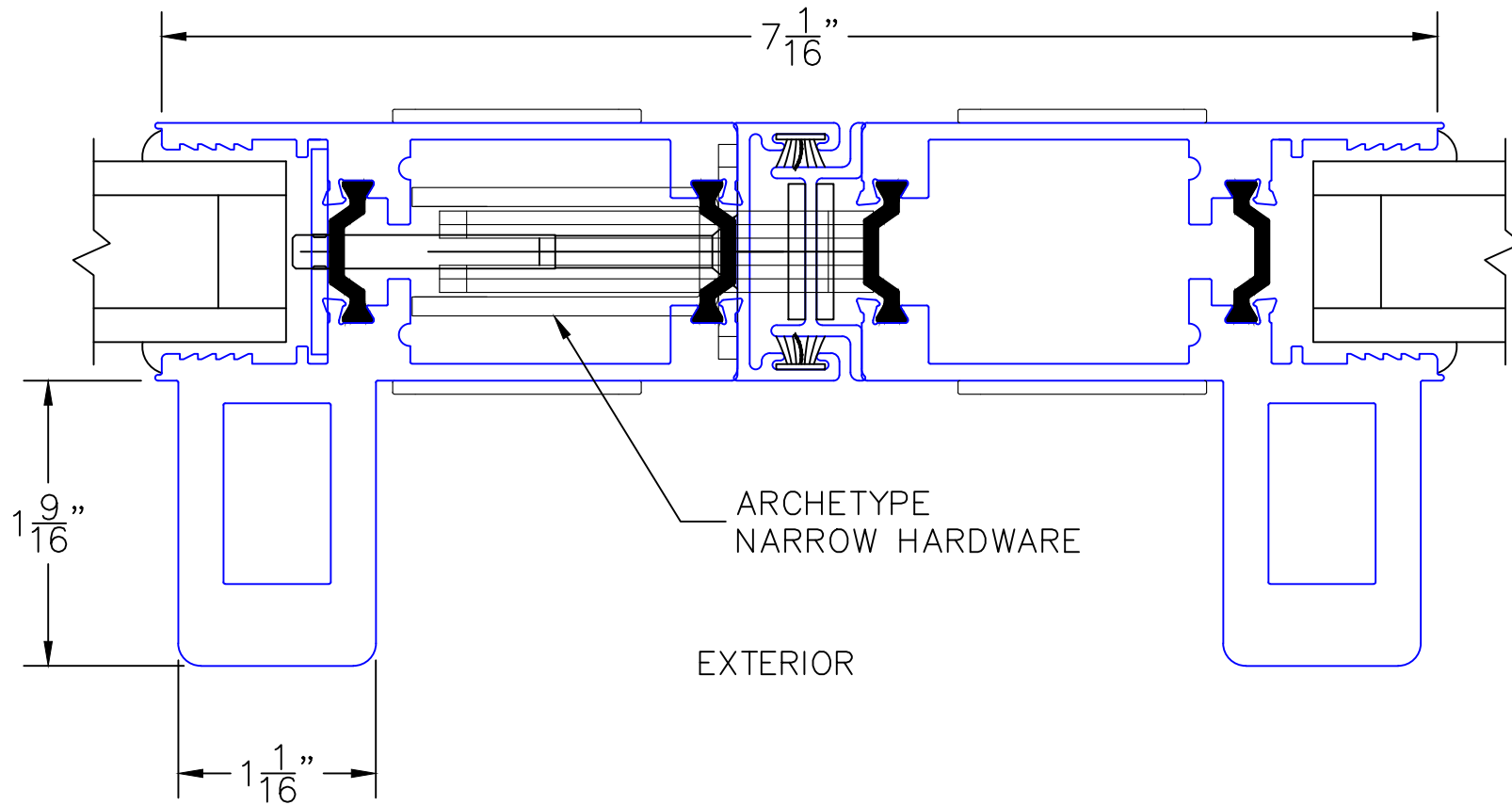

OPTIONS AND UPGRADES

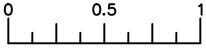

(USE RULER TO SCALE DIMENSIONS IN INCHES)

SCALE: FULL

2

ARCHETYPE
LOCK STILE

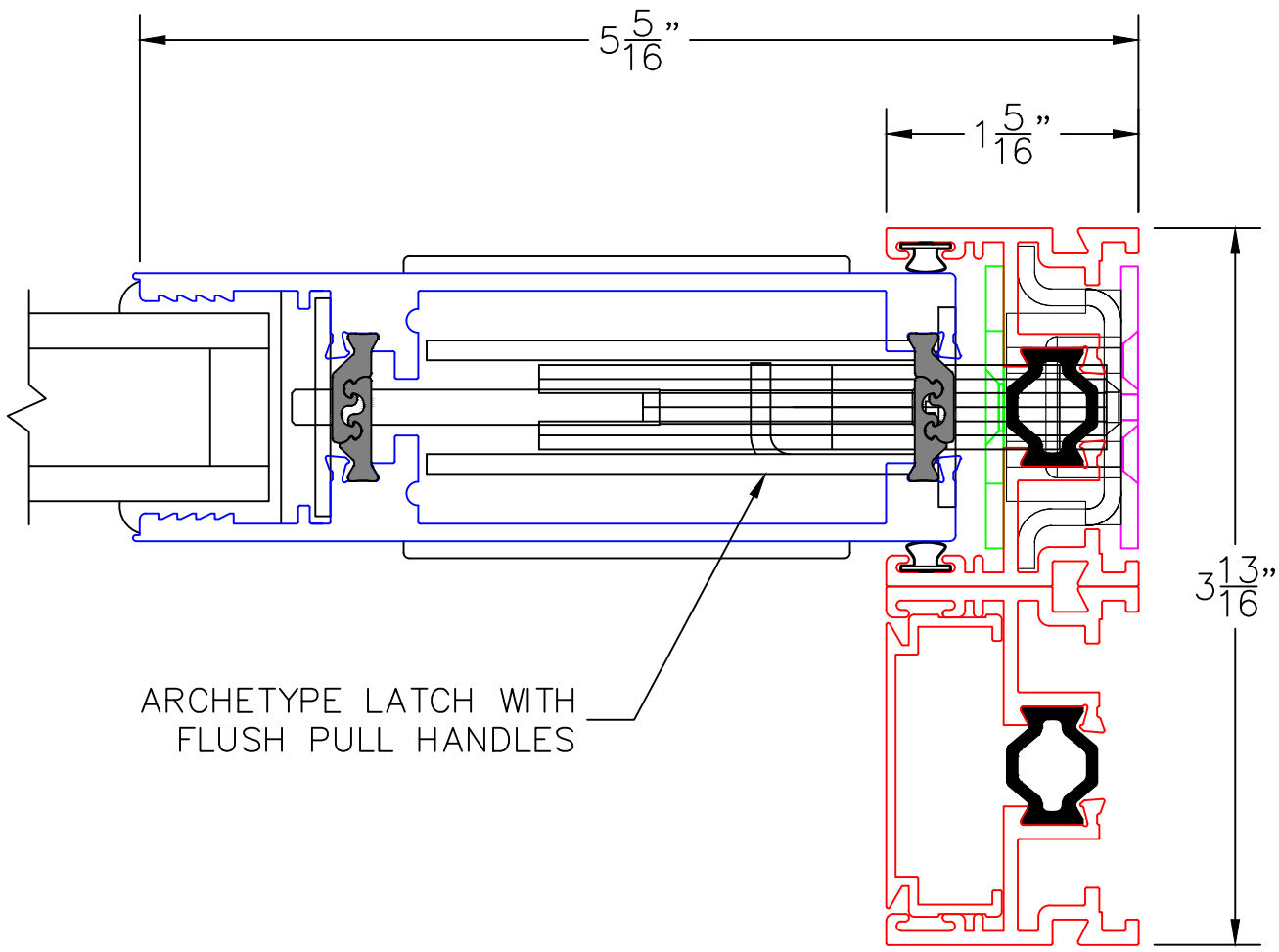

ARCHETYPE LATCH WITH
FLUSH PULL HANDLES

EXTERIOR

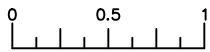

(USE RULER TO SCALE DIMENSIONS IN INCHES)

SCALE: FULL

OPTIONS AND UPGRADES

2A

HP1-T ARCHETYPE LOCK STILE

ARCHETYPE LATCH WITH
FLUSH PULL HANDLES

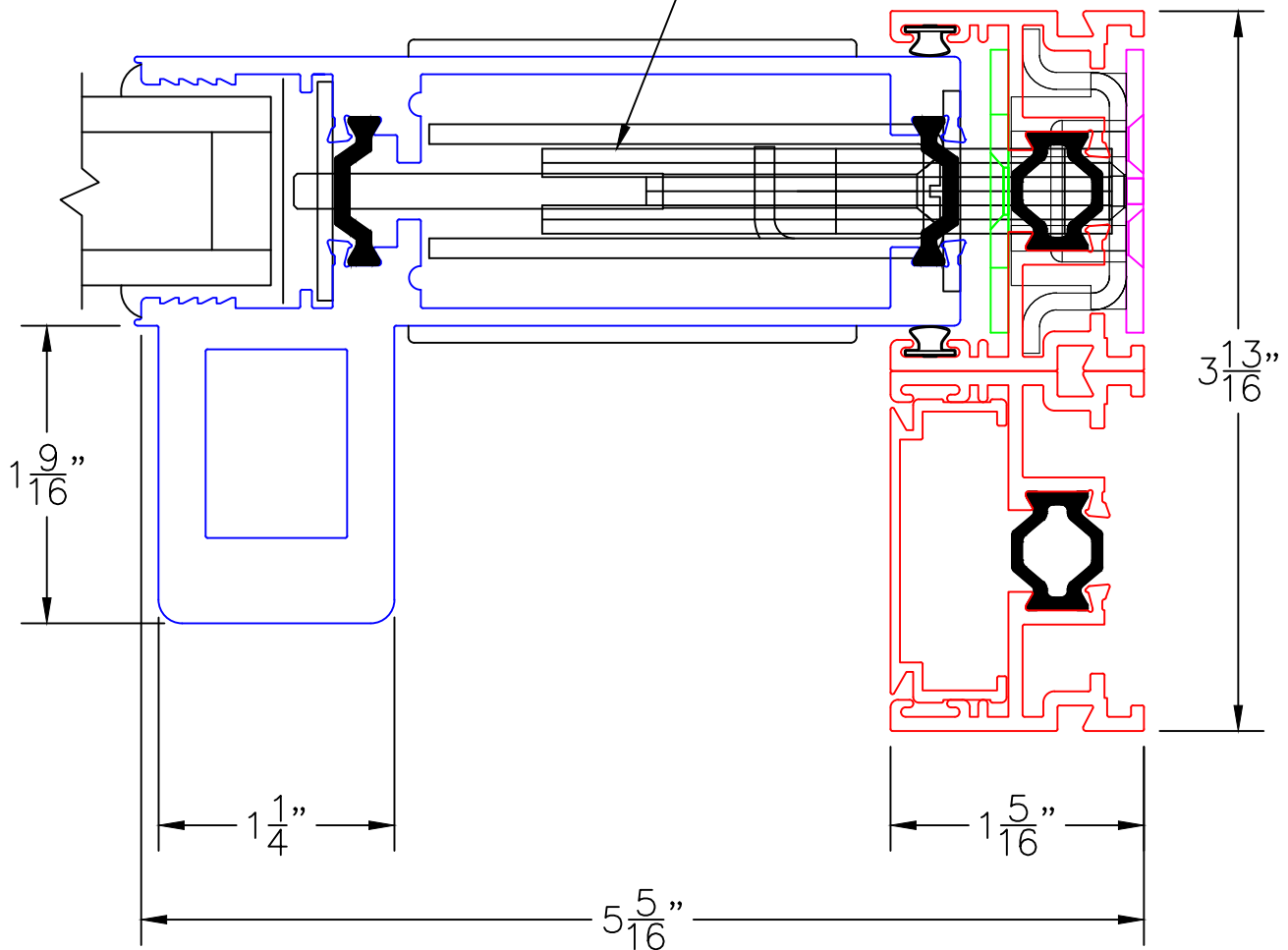

EXTERIOR

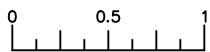

(USE RULER TO SCALE DIMENSIONS IN INCHES)

SCALE: FULL

OPTIONS AND UPGRADES

2B

HP2-T ARCHETYPE NARROW LOCK STILE

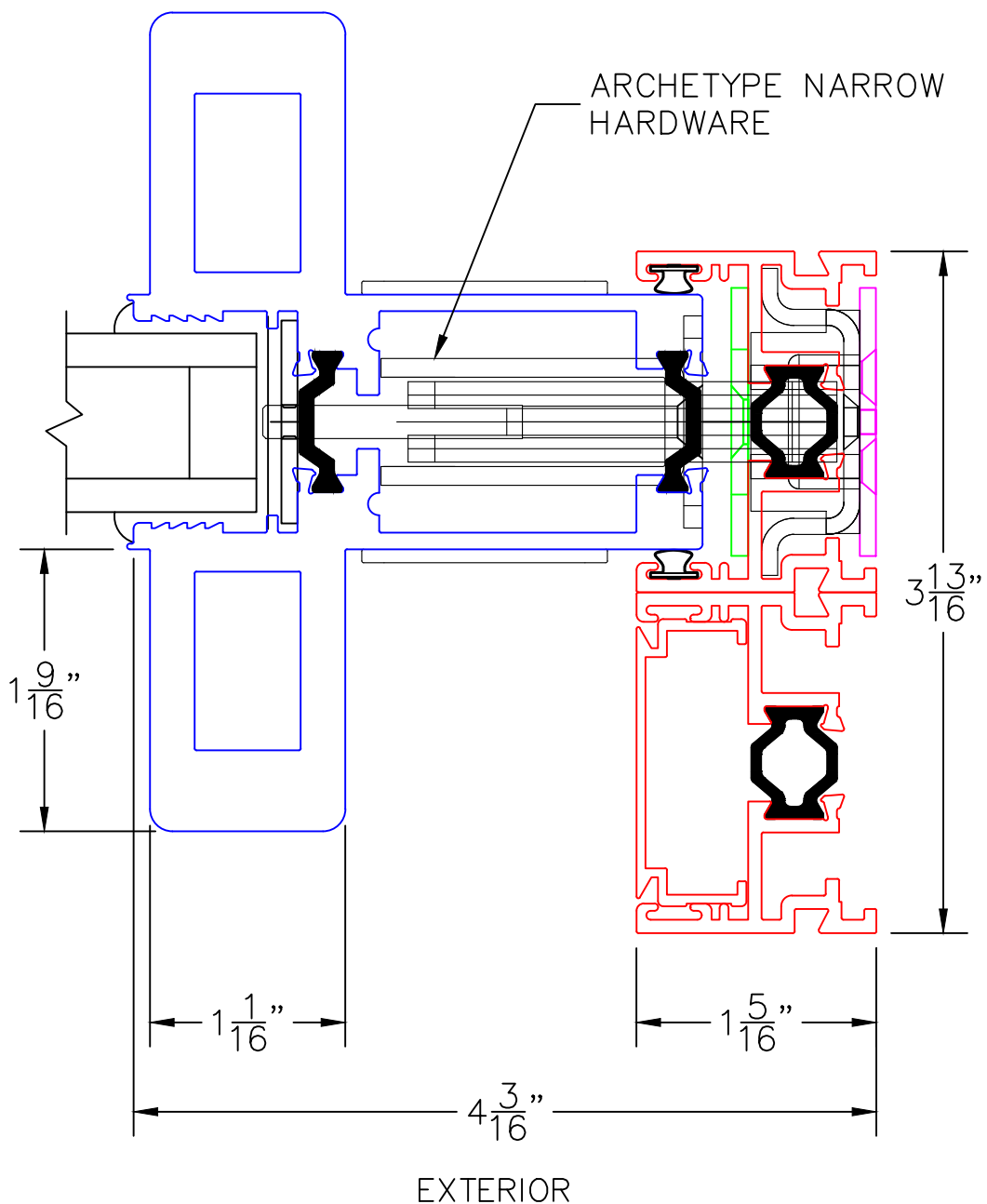

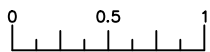

(USE RULER TO SCALE DIMENSIONS IN INCHES)

SCALE: FULL

OPTIONS AND UPGRADES

2C

HP1-T ARCHETYPE NARROW LOCK STILE

ARCHETYPE
NARROW LATCH

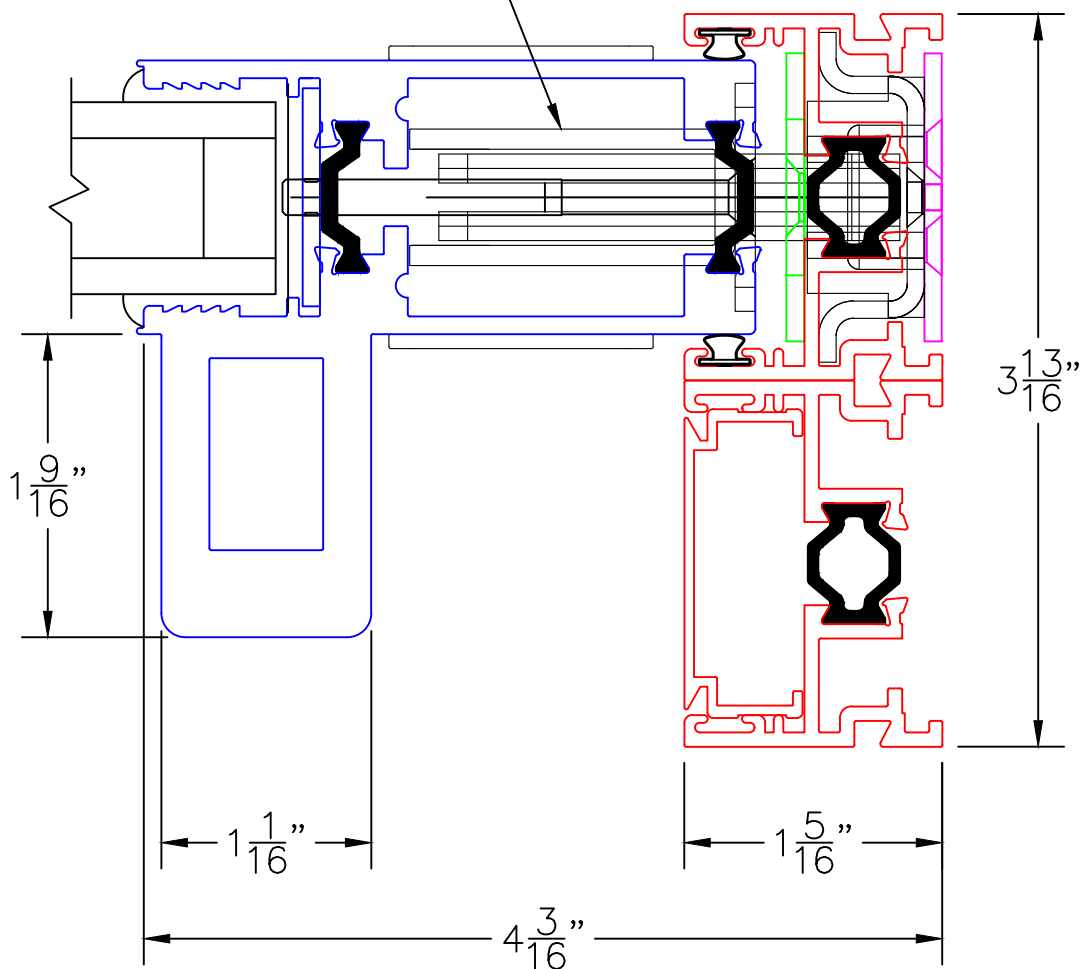

EXTERIOR