

(USE RULER TO SCALE DIMENSIONS IN INCHES)

SCALE: 1/4

MULTI-SLIDE CORNER DOOR DETAILS WITH SCREENS - OXVXO SHOWN

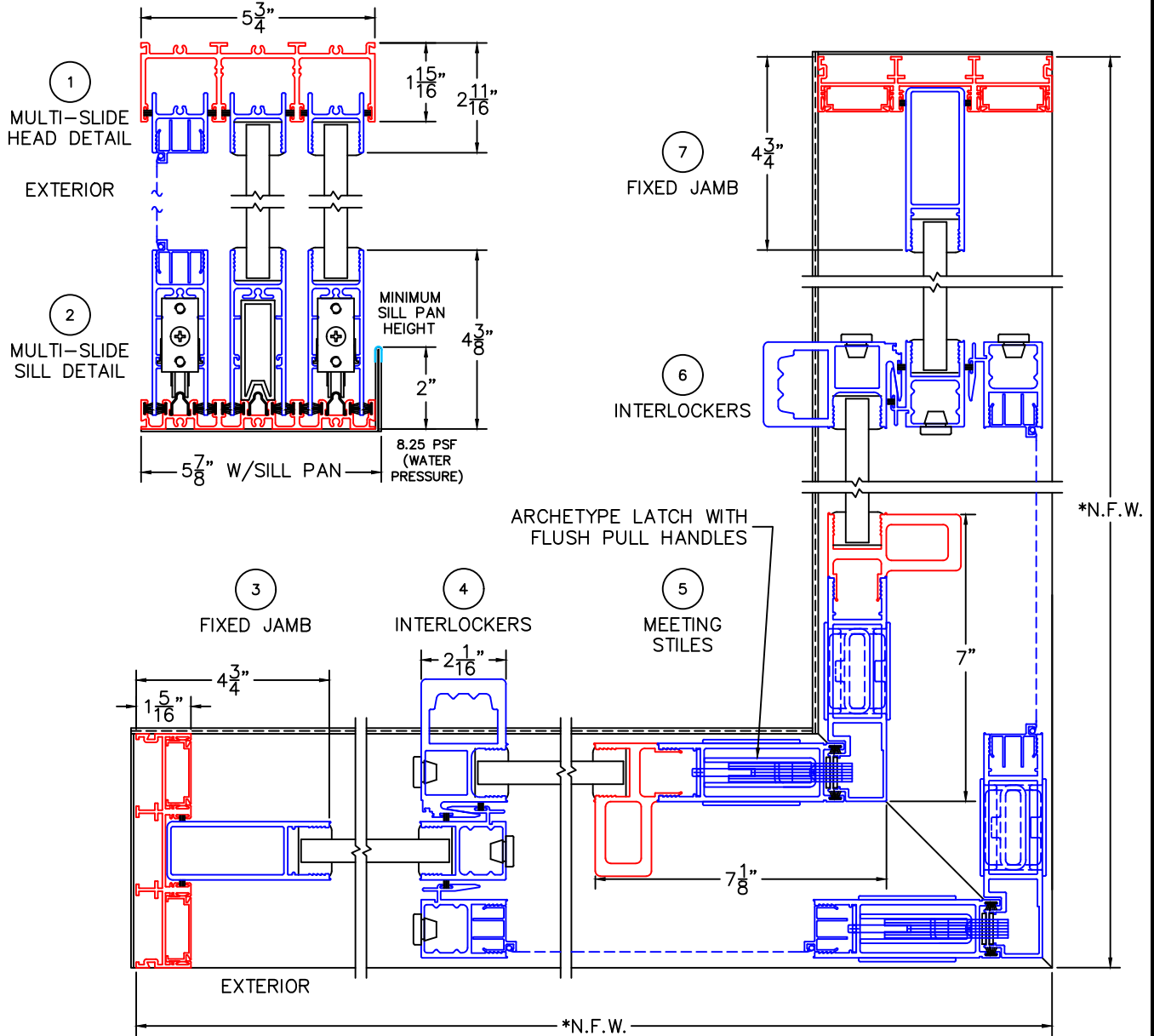

NOTE: CENTERLINES ARE NOT DIVIDED EQUALLY; CONFIRM CENTERLINES WHEN REQUIRED.

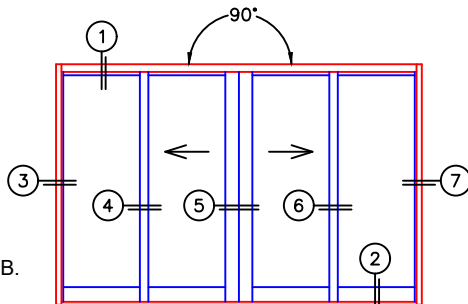

OXVXO DOOR

- *NET FRAME WIDTH DOES NOT INCLUDE SILL PAN.
- SILL PAN EXTENDS 1/8" BEYOND EACH JAMB.
- PLAN VIEW DOES NOT SHOW RISER.
- HP EXTRUSION LOCATIONS MAY VARY.
- EXTERIOR RATED PRODUCTS HAVE WEEP SLOTS ON HORIZONTAL SILLS.
- GLASS PENETRATION: 11/16"

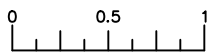

(USE RULER TO SCALE DIMENSIONS IN INCHES)

SCALE: FULL

OXX DOOR



MULTI-SLIDE
HEAD DETAIL

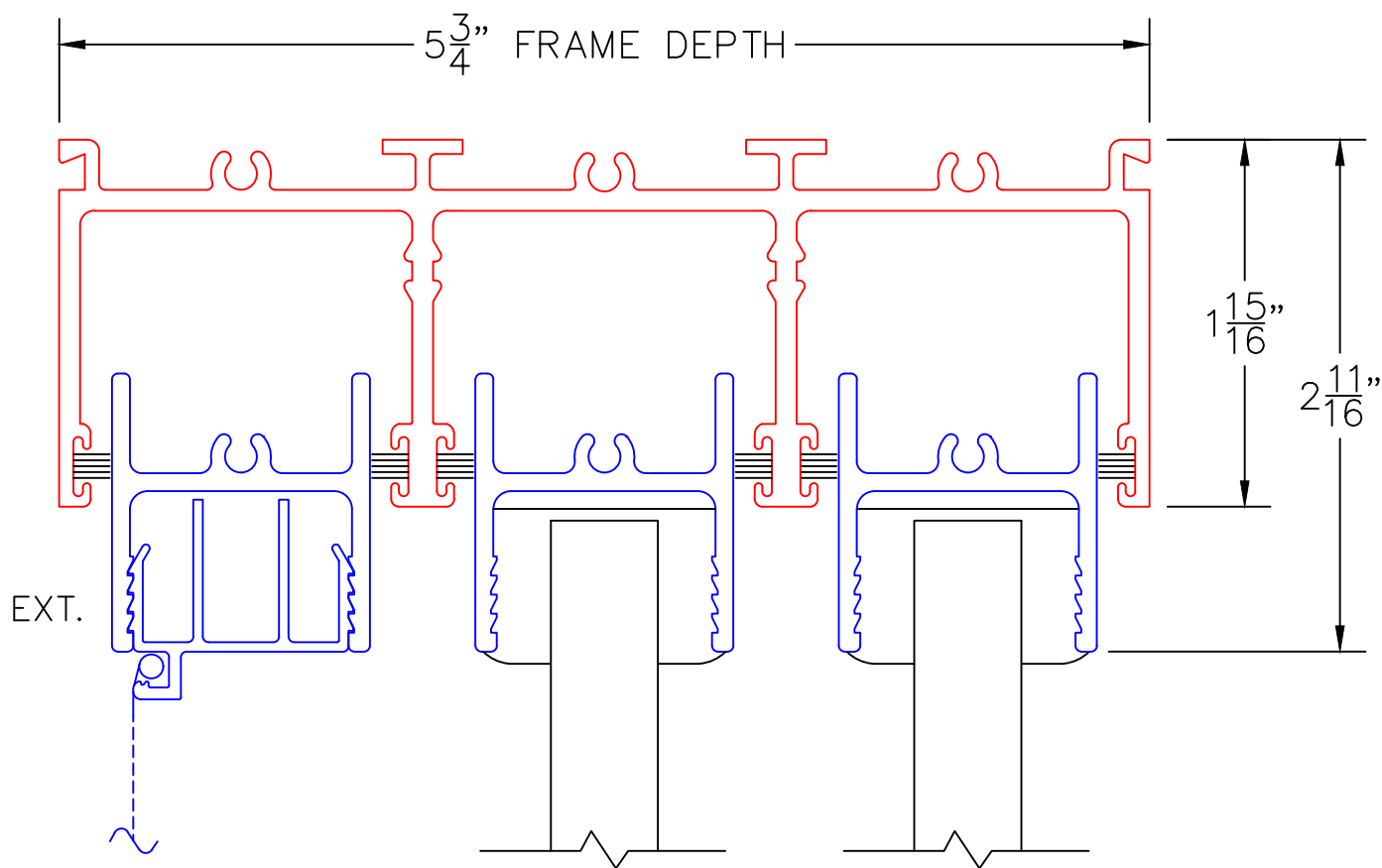

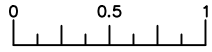

(USE RULER TO SCALE DIMENSIONS IN INCHES)

SCALE: FULL

OXX DOOR

A2 ROLLERS

EXTERIOR

2

MULTI-SLIDE
SILL DETAIL

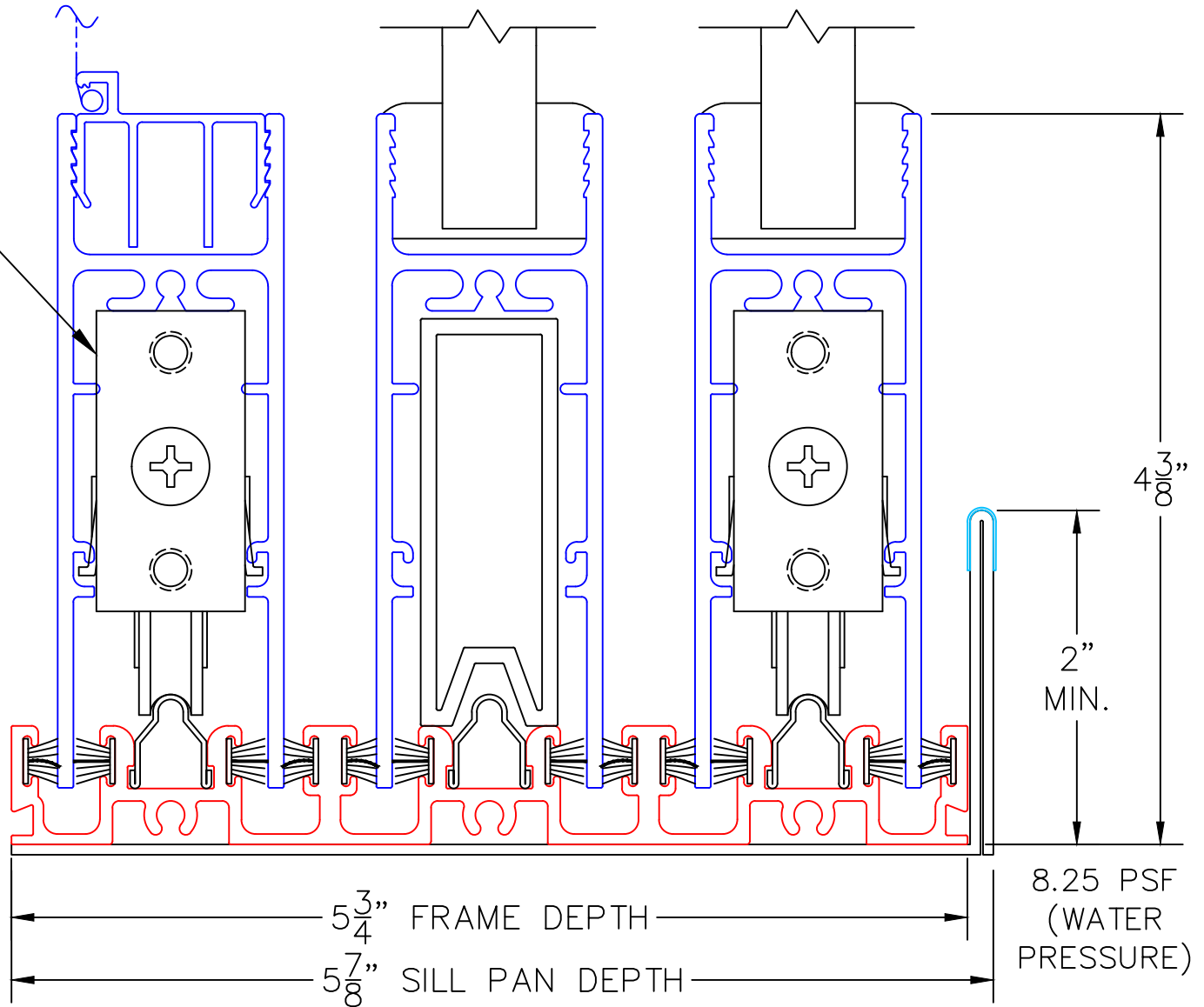

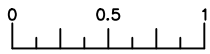

(USE RULER TO SCALE DIMENSIONS IN INCHES)

SCALE: FULL

OX DOOR

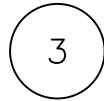

FIXED JAMB

$\frac{1}{8}$ " FOR
SILL PAN

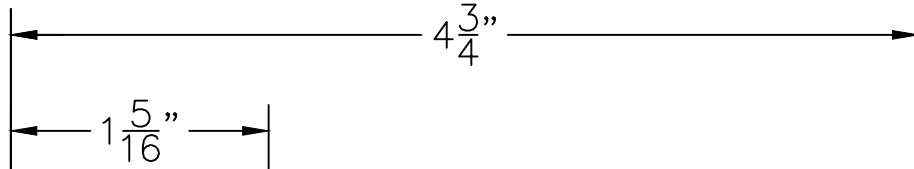

$5\frac{3}{4}$ "
FRAME
DEPTH

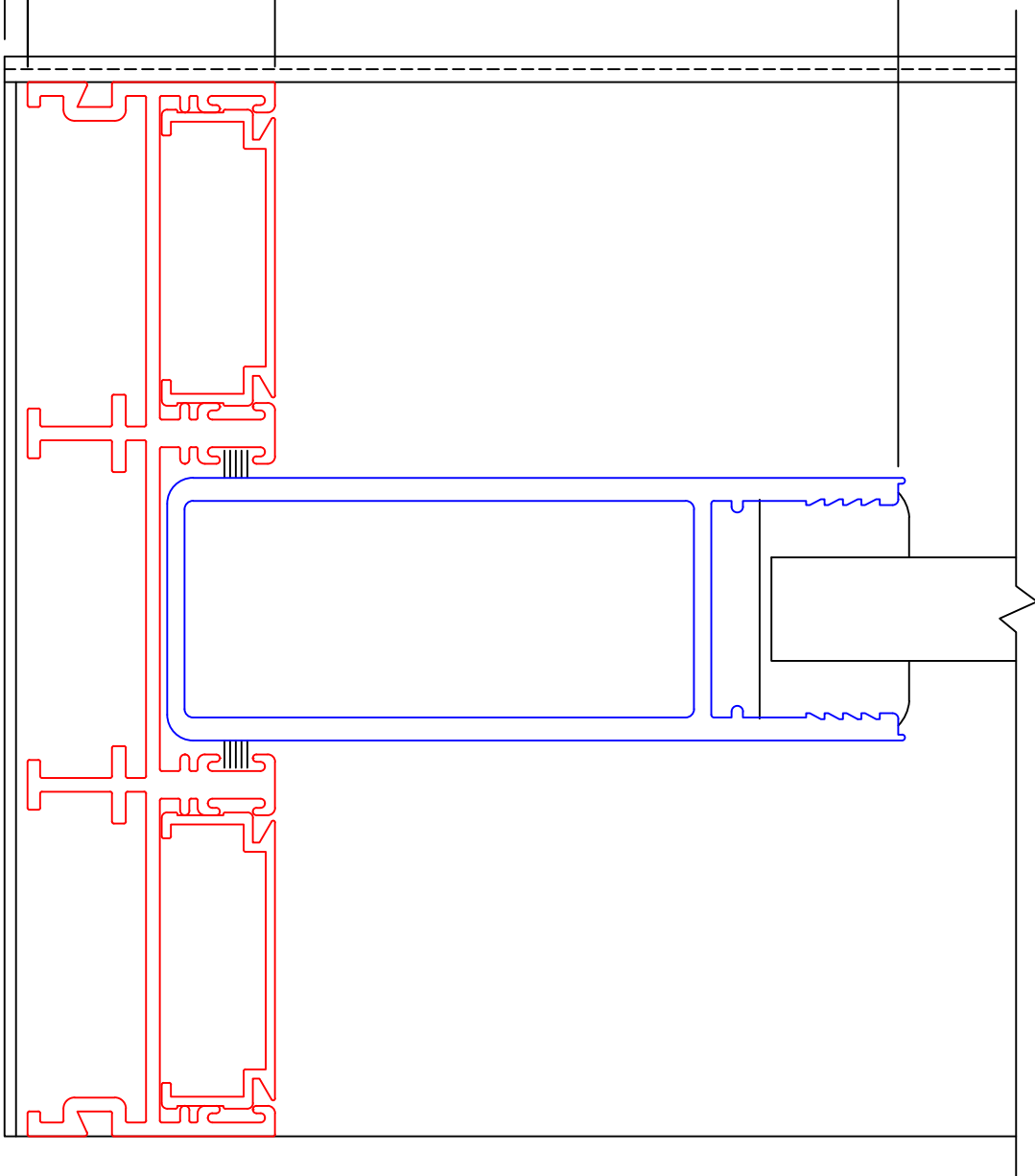

EXTERIOR

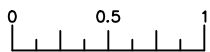

(USE RULER TO SCALE DIMENSIONS IN INCHES)

SCALE: FULL

OXX DOOR

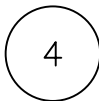

INTERLOCKERS

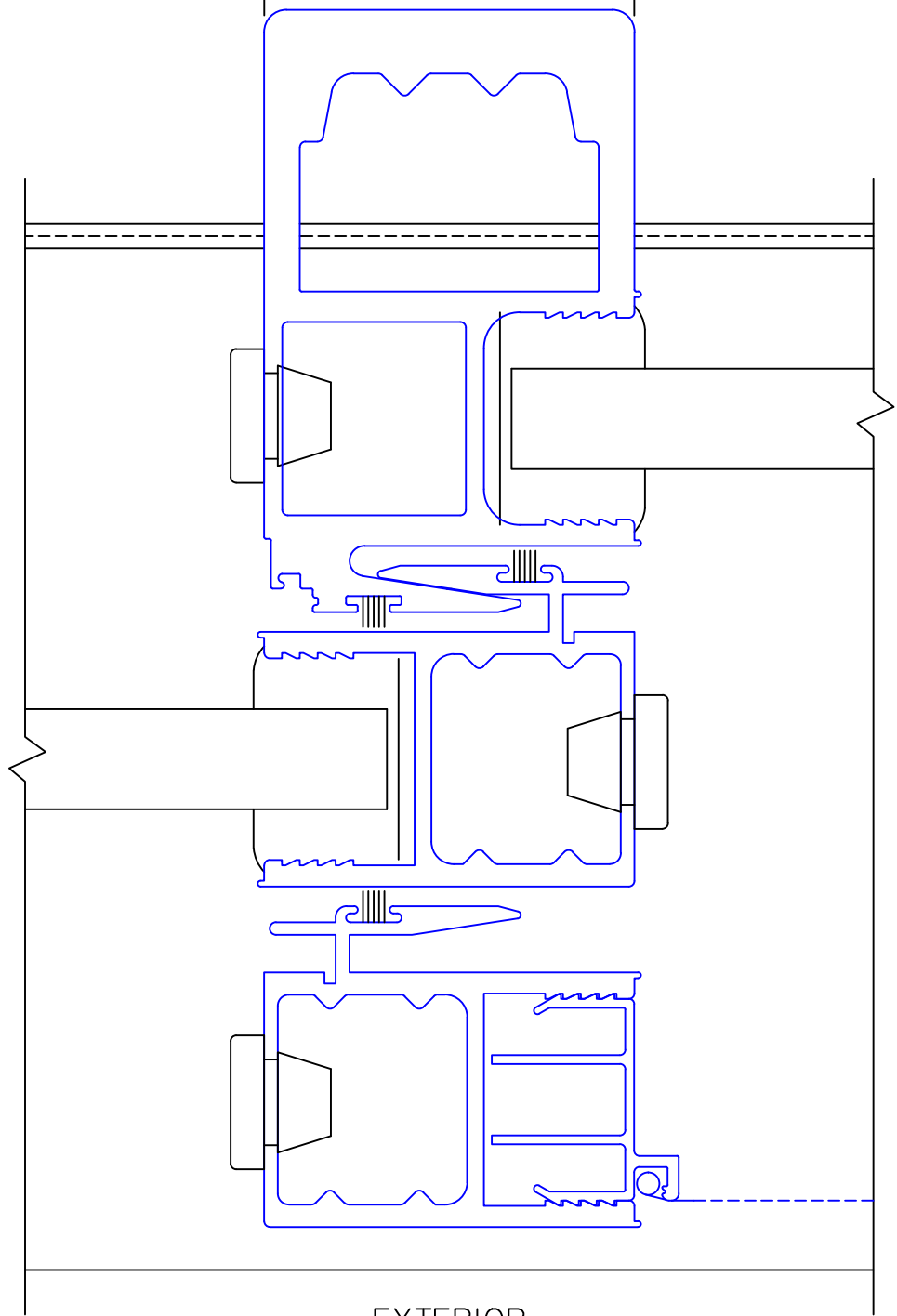
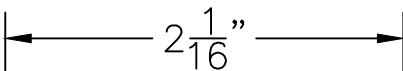

EXTERIOR

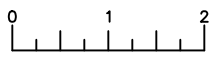

(USE RULER TO SCALE DIMENSIONS IN INCHES)

SCALE: 1/2

OXVXO DOOR

5

MEETING
STILES

ARCHETYPE LATCH
WITH FLUSH
PULL HANDLES

90°

11 ¹/₁₆''

11 ³/₁₆''

EXTERIOR

