

FLEETWOOD
WINDOWS & DOORS
FleetwoodUSA.com

NORWOOD 3070EX M/S
90XXXXXXXXXXXX STANDARD CONFIGURATION
NO SCREENS

ORDER NO.:-	
ITEM NO.:	
REQUIRED DEALER INFO.	
A (NET FRAME WIDTH)	
B (NET FRAME WIDTH)	
C (NET FRAME HEIGHT)	
SILL PAN HEIGHT(INTERIOR LEG)	(3/4", 1-1/16", 1-7/16" OR 1-7/8")

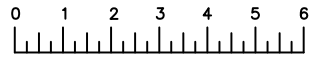

(USE RULER TO SCALE DIMENSIONS IN INCHES)

SCALE: 1/4

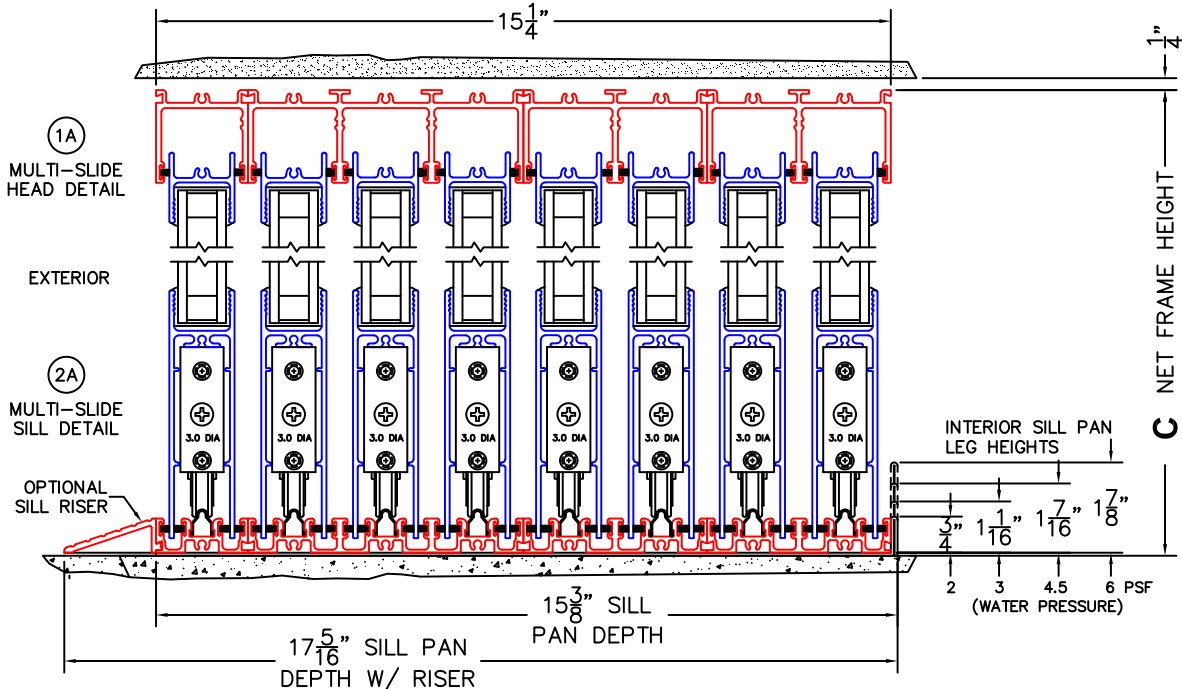
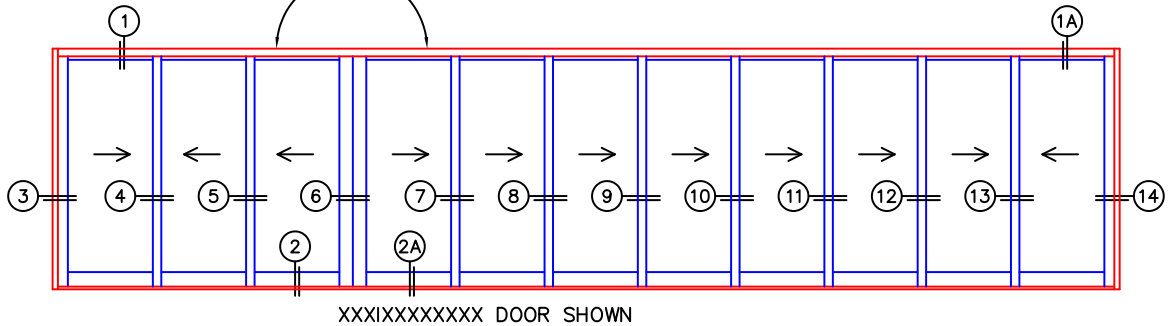
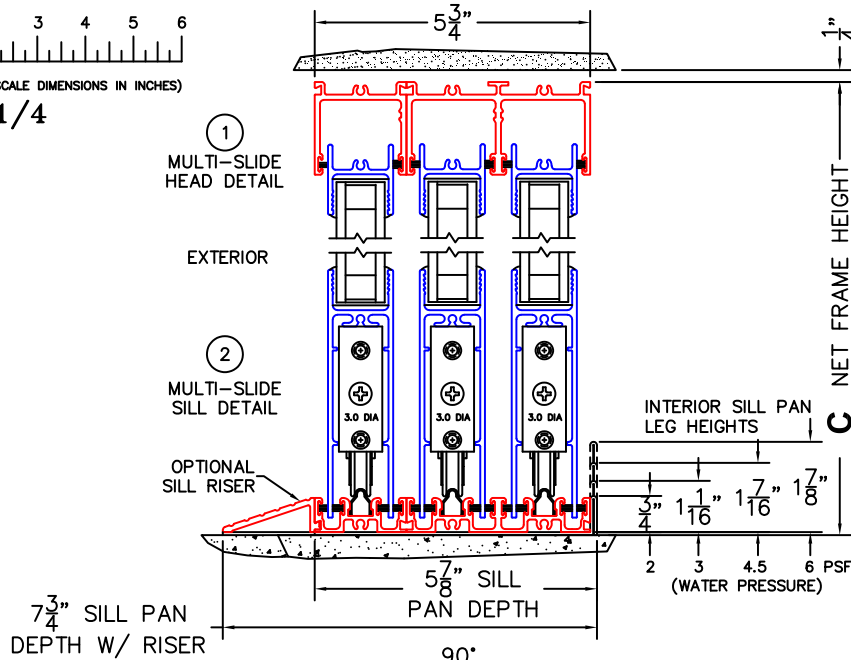

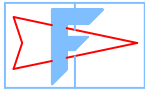

NORWOOD 3070EX M/S
90XXX-XXXXXXXX STANDARD CONFIGURATION
NO SCREENS

ORDER NO.:

ITEM NO.:

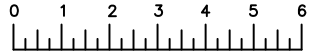

(USE RULER TO SCALE DIMENSIONS IN INCHES)

SCALE: 1/4

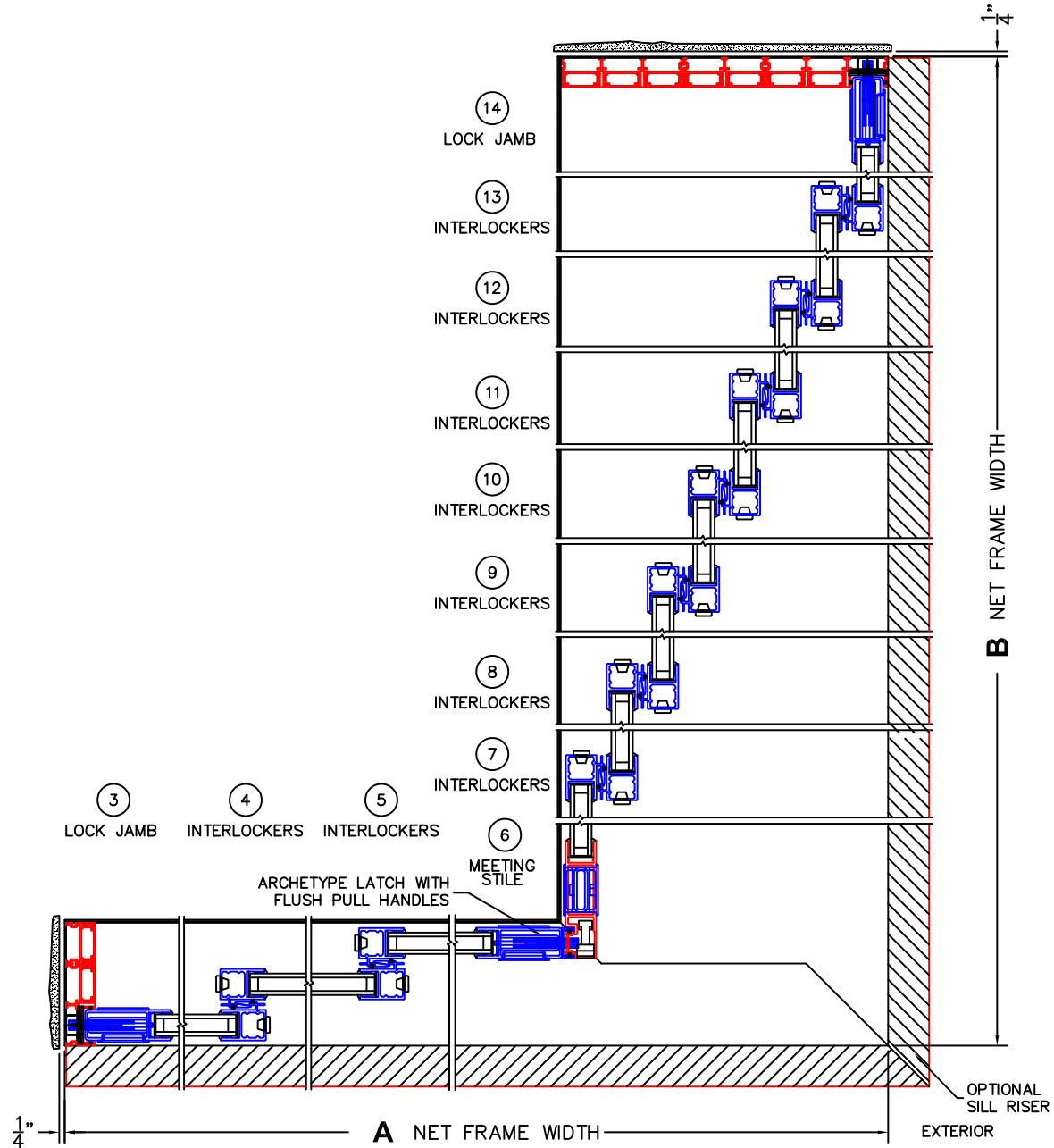

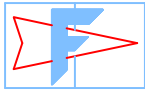

FLEETWOOD
 WINDOWS & DOORS
 FleetwoodUSA.com

NORWOOD 3070EX M/S
 90XXX-XXXXXXXX STANDARD CONFIGURATION
 NO SCREENS

ORDER NO.:

ITEM NO.:

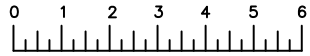

(USE RULER TO SCALE DIMENSIONS IN INCHES)

SCALE: 1/4

