

FLEETWOOD
WINDOWS & DOORS
FleetwoodUSA.com

NORWOOD 3070EX M/S
90°OXXIXXXP STANDARD CONFIGURATION
NO SCREENS

ORDER NO.:

ITEM NO.:

SCALE: 1/4

REQUIRED DEALER INFO.

A (NET FRAME WIDTH)	
B (DAYLIGHT WIDTH)	
C (NET FRAME HEIGHT)	
SILL PAN HEIGHT(INTERIOR LEG) (3/4", 1-1/16", 1-7/16" OR 1-7/8")	

CALCULATED VALUES (FLEETWOOD SUPPLIED)

D (POCKET WIDTH)	
E (NET FRAME WIDTH)	

NOTES:

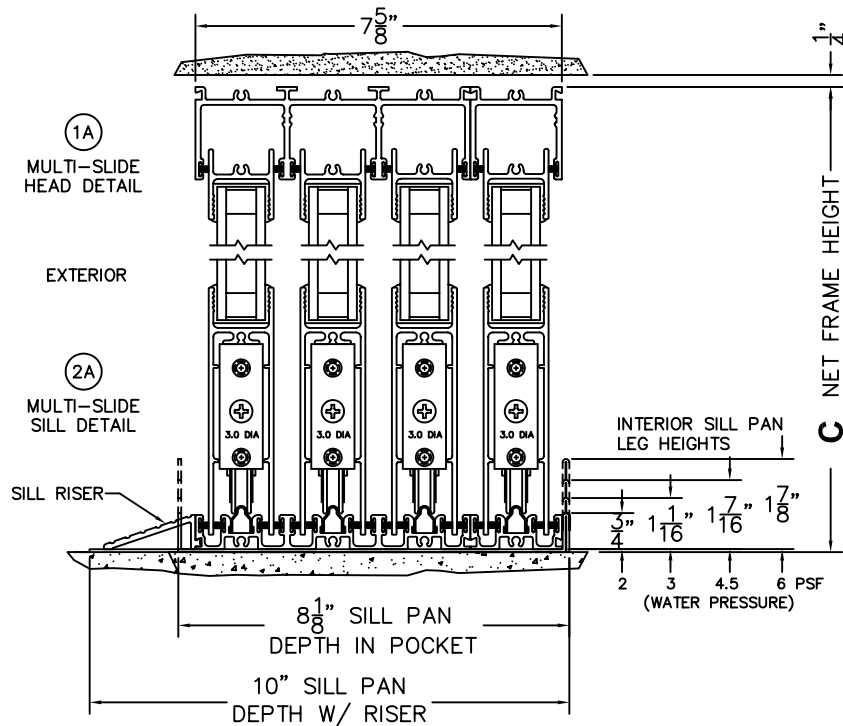
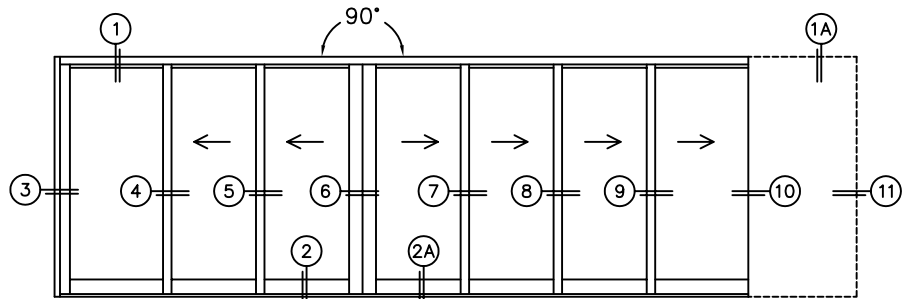
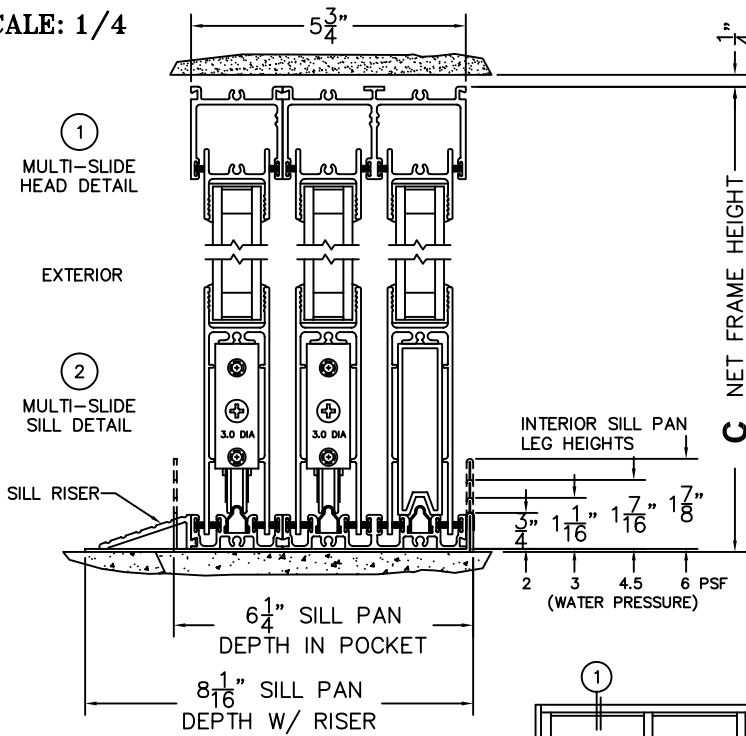

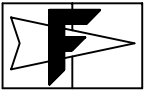

FLEETWOOD
WINDOWS & DOORS
FleetwoodUSA.com

NORWOOD 3070EX M/S
90°OXXIXXXXP STANDARD CONFIGURATION
NO SCREENS

ORDER NO.:

ITEM NO.:

SCALE: 1/8

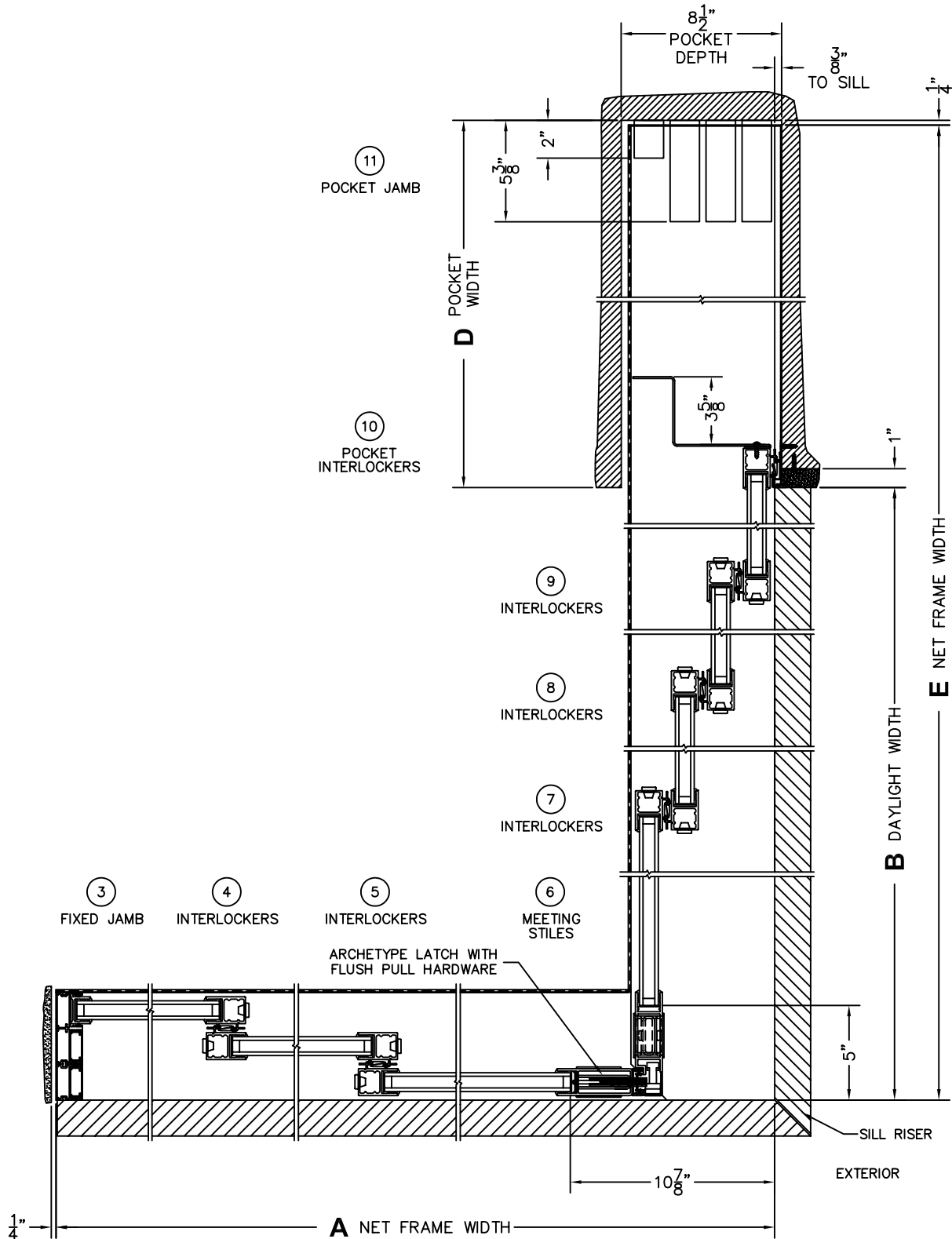

*CAUTION: WHEN CONSTRUCTING POCKET NOTE THAT DAYLIGHT WIDTH DOES NOT INCLUDE 1" SET BACK FOR POST INTERLOCKER.

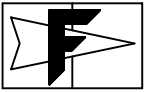

FLEETWOOD
WINDOWS & DOORS
FleetwoodUSA.com

NORWOOD 3070EX M/S
90°OXXIXXXP STANDARD CONFIGURATION
NO SCREENS

ORDER NO.:

ITEM NO.:

SCALE: 1/4

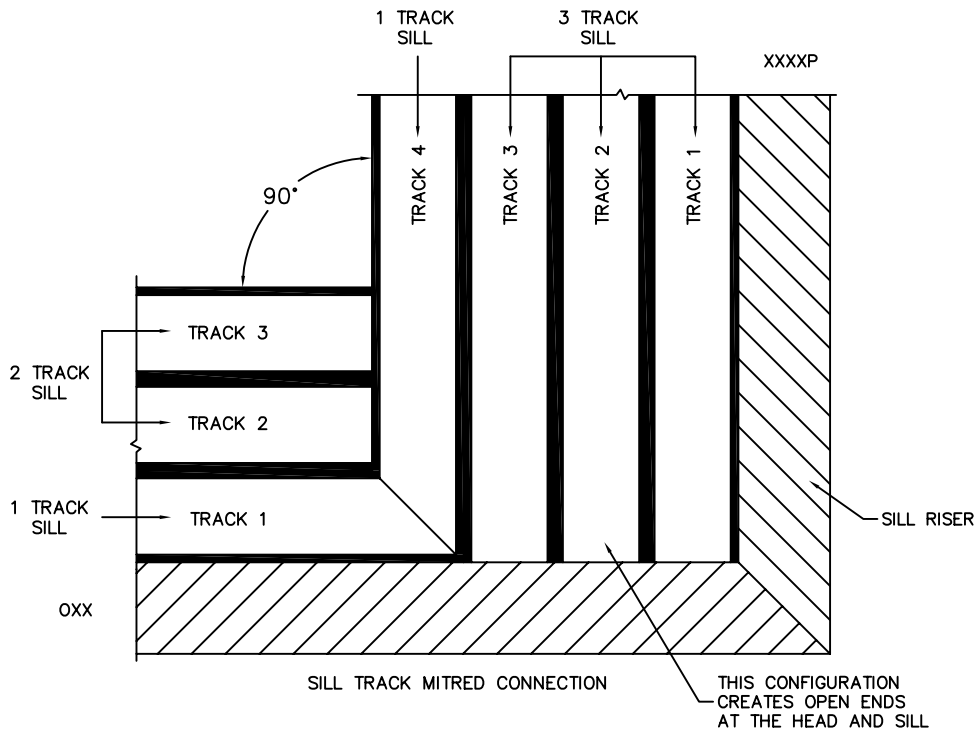

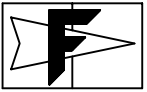

FLEETWOOD
WINDOWS & DOORS
FleetwoodUSA.com

NORWOOD 3070EX M/S
90°OXXIXXXXP STANDARD CONFIGURATION
NO SCREENS

ORDER NO.:

ITEM NO.:

SCALE: 1/8

POCKET VIEW:
PANELS SHOWN IN OPEN POSITION

