



FLEETWOOD
WINDOWS & DOORS
FleetwoodUSA.com

NORWOOD 3070EX M/S
90°IPXIXXP STANDARD CONFIG.
WITH SCREENS

ORDER NO.:

ITEM NO.:

REQUIRED DEALER INFO.

A (DAYLIGHT WIDTH)	
B (DAYLIGHT WIDTH)	
C (NET FRAME HEIGHT)	
SILL PAN HEIGHT(INTERIOR LEG)	(3/4", 1-1/16", 1-7/16" OR 1-7/8")

CALCULATED VALUES (FLEETWOOD SUPPLIED)

D (POCKET WIDTH)	
E (NET FRAME WIDTH)	
F (POCKET WIDTH)	
G (NET FRAME WIDTH)	

NOTES:

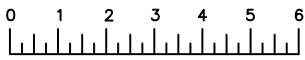

(USE RULER TO SCALE DIMENSIONS IN INCHES)

SCALE: 1/4

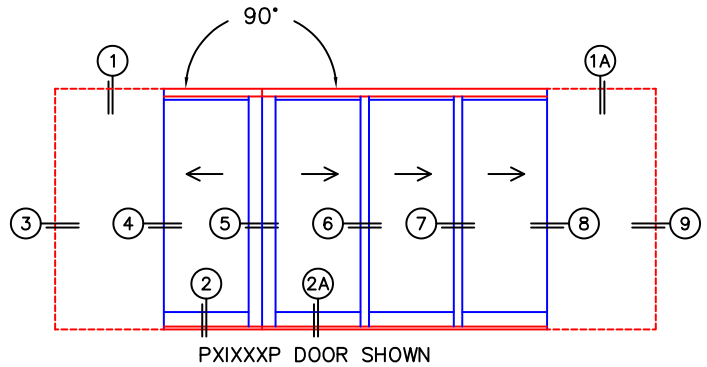
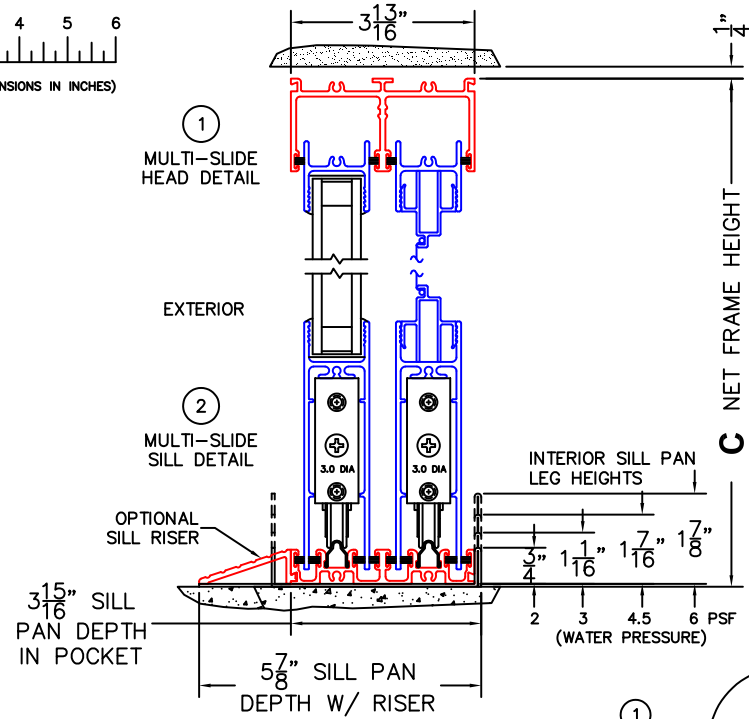

PXIXXP DOOR SHOWN

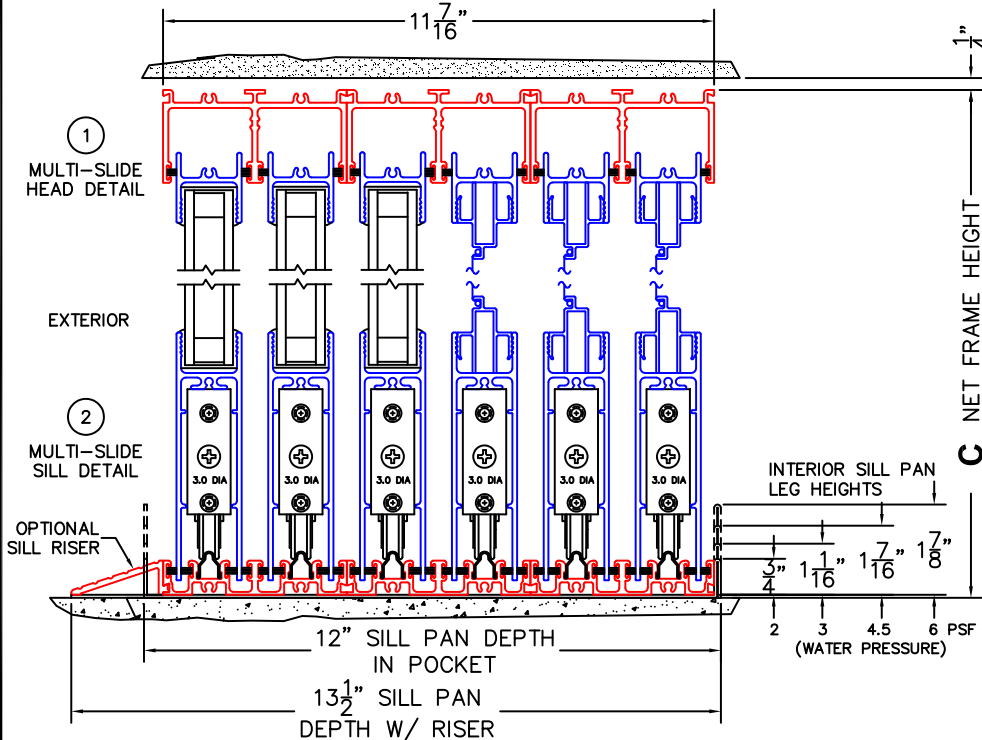

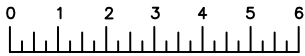
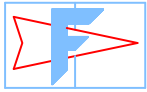

(USE RULER TO SCALE DIMENSIONS IN INCHES)

SCALE: 1/8

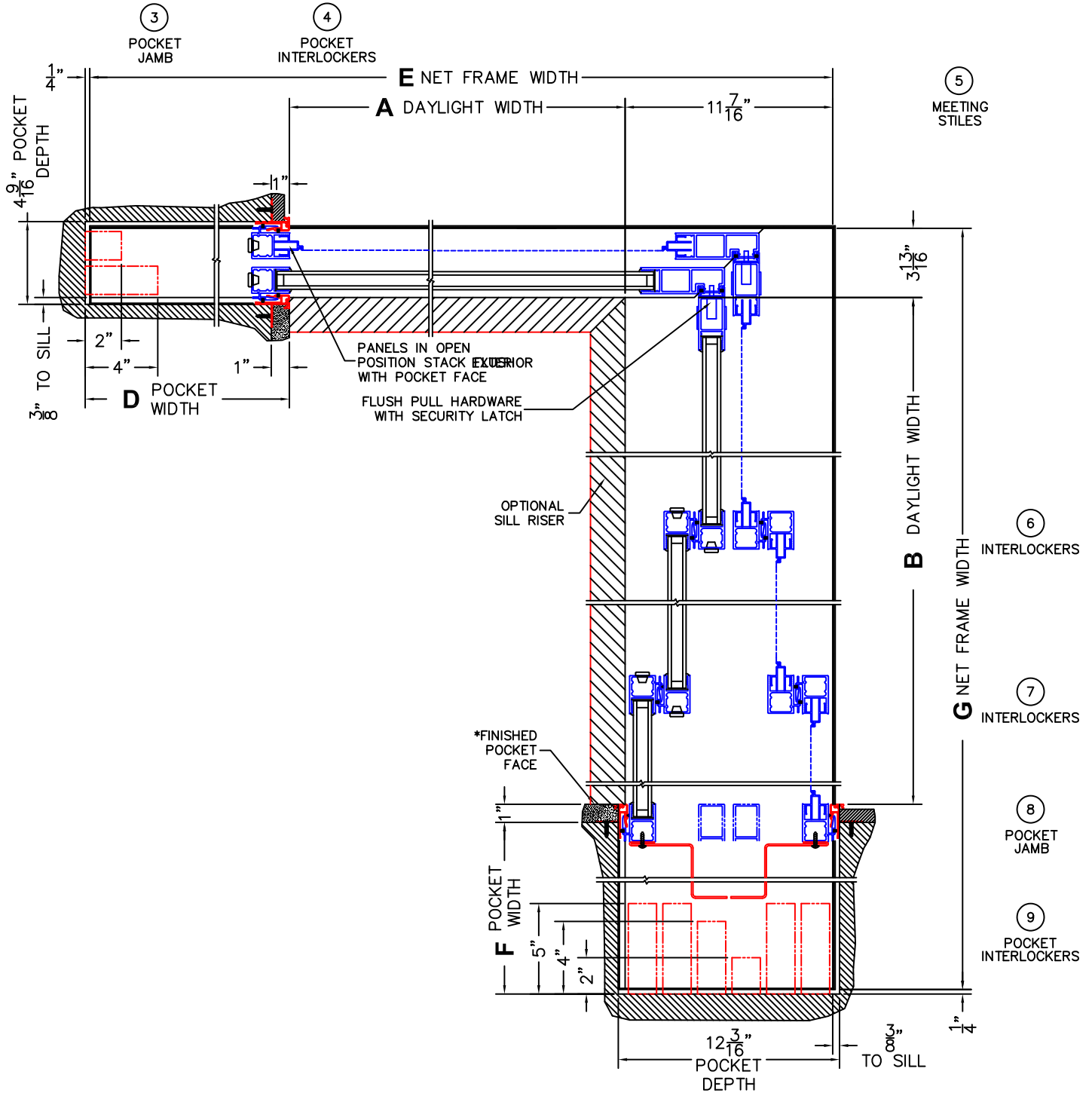

*CAUTION: WHEN CONSTRUCTING POCKET NOTE THAT DAYLIGHT WIDTH DOES NOT INCLUDE 1" SET BACK FOR POST INTERLOCKER.

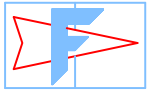

FLEETWOOD
WINDOWS & DOORS
FleetwoodUSA.com

NORWOOD 3070EX M/S
90°IPXIXXP STANDARD CONFIG.
WITH SCREENS

ORDER NO.:

ITEM NO.:

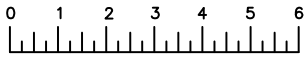

(USE RULER TO SCALE DIMENSIONS IN INCHES)

SCALE: 1/4

