

**FLEETWOOD**  
WINDOWS & DOORS  
FleetwoodUSA.com

**NORWOOD 3070EX M/S**  
90°IOIXXXP STANDARD CONFIGURATION  
NO SCREENS

ORDER NO.:

ITEM NO.:

REQUIRED DEALER INFO.

<b>A</b> (NET FRAME WIDTH)	
<b>B</b> (DAYLIGHT WIDTH)	
<b>C</b> (NET FRAME HEIGHT)	
SILL PAN HEIGHT(INTERIOR LEG)	3/4", 1-1/16", 1-7/16" OR 1-7/8"

CALCULATED VALUES (FLEETWOOD SUPPLIED)

<b>D</b> (POCKET WIDTH)	
<b>E</b> (NET FRAME WIDTH)	

NOTES:



(USE RULER TO SCALE DIMENSIONS IN INCHES)

SCALE: 1/4

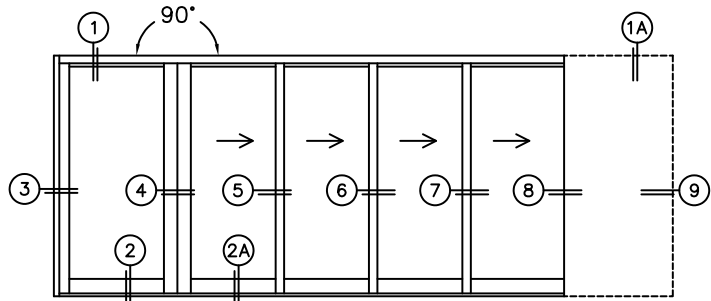
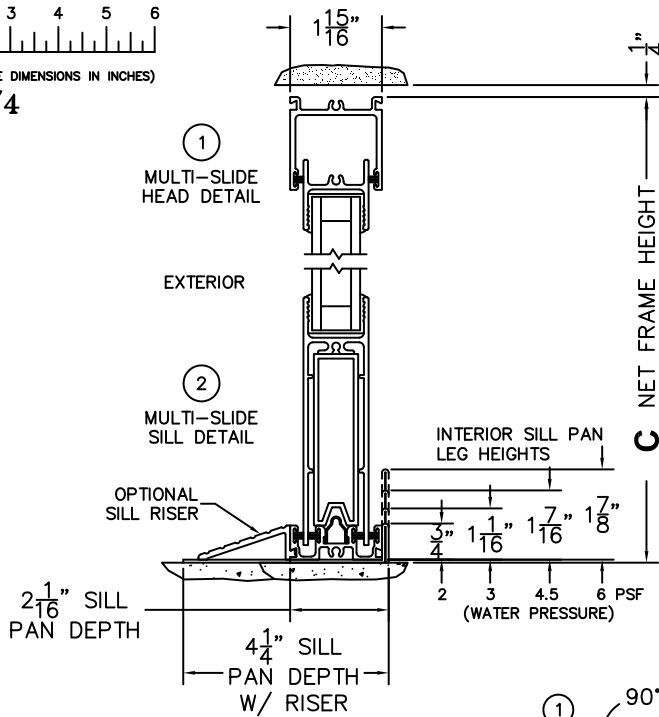

OIXXXP DOOR SHOWN

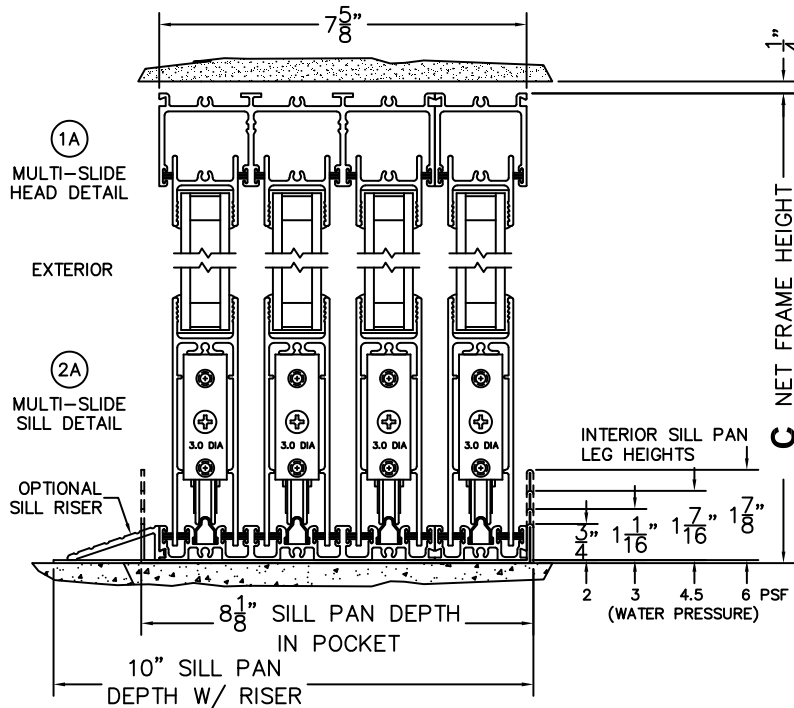

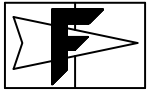

**FLEETWOOD**  
WINDOWS & DOORS  
FleetwoodUSA.com

**NORWOOD 3070EX M/S**  
90°IOIXXXP STANDARD CONFIGURATION  
NO SCREENS

ORDER NO.:

ITEM NO.:



(USE RULER TO SCALE DIMENSIONS IN INCHES)

SCALE: 1/4

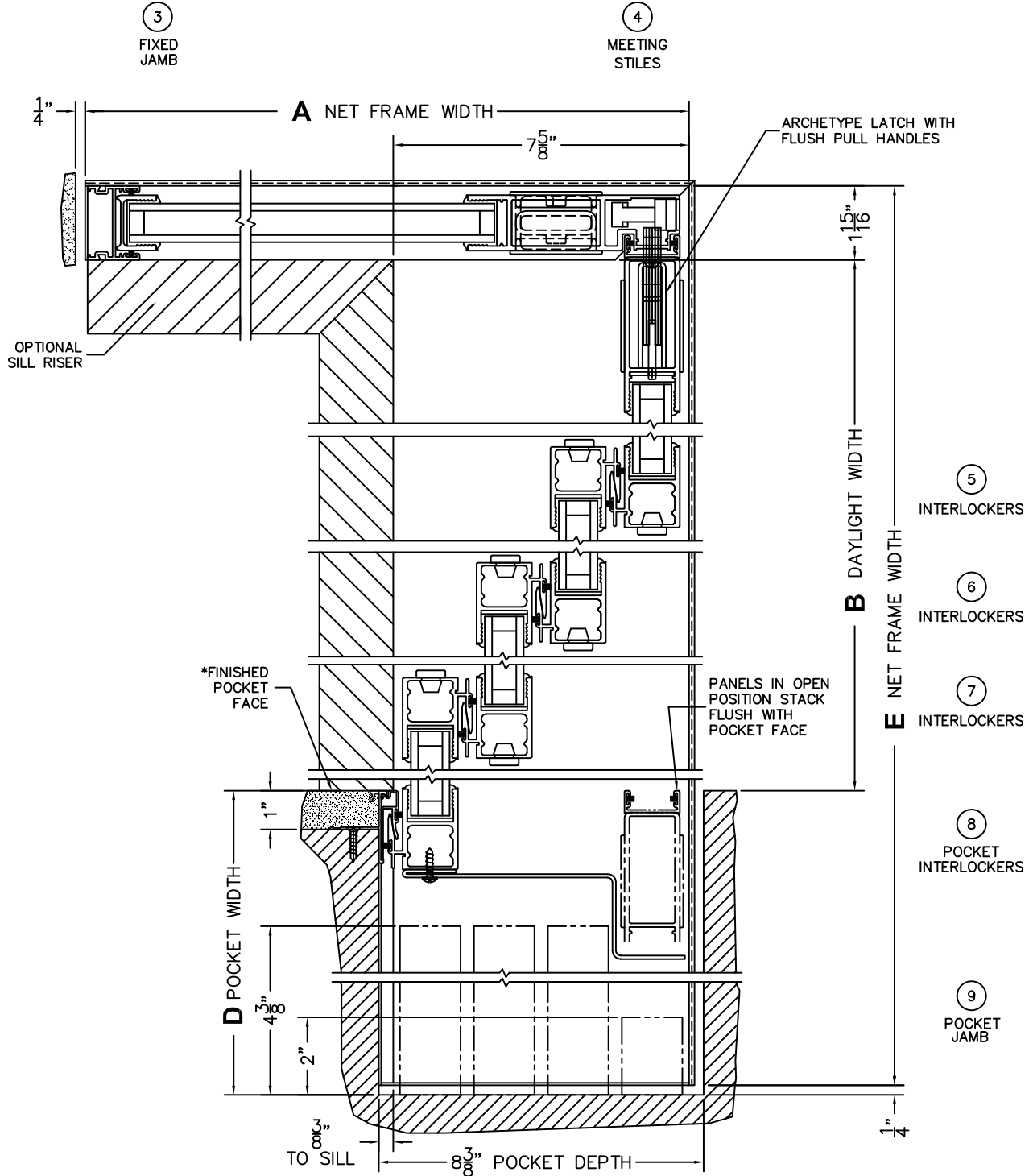

\*CAUTION: WHEN CONSTRUCTING POCKET NOTE THAT DAYLIGHT WIDTH DOES NOT INCLUDE 1" SET BACK FOR POST INTERLOCKER.

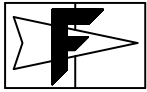

**FLEETWOOD**  
WINDOWS & DOORS  
FleetwoodUSA.com

**NORWOOD 3070EX M/S**  
90°IOIXXXP STANDARD CONFIGURATION  
NO SCREENS

ORDER NO.:

ITEM NO.:

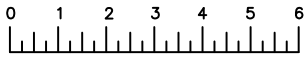

(USE RULER TO SCALE DIMENSIONS IN INCHES)

SCALE: 1/4

SILL TRACK MITRED CONNECTION

