

FLEETWOOD
WINDOWS & DOORS
FleetwoodUSA.com

NORWOOD 3050
90°PXIXXP STANDARD CONFIGURATION
NO SCREENS

ORDER NO.:

ITEM NO.:



(USE RULER TO SCALE DIMENSIONS IN INCHES)

SCALE: 1/8

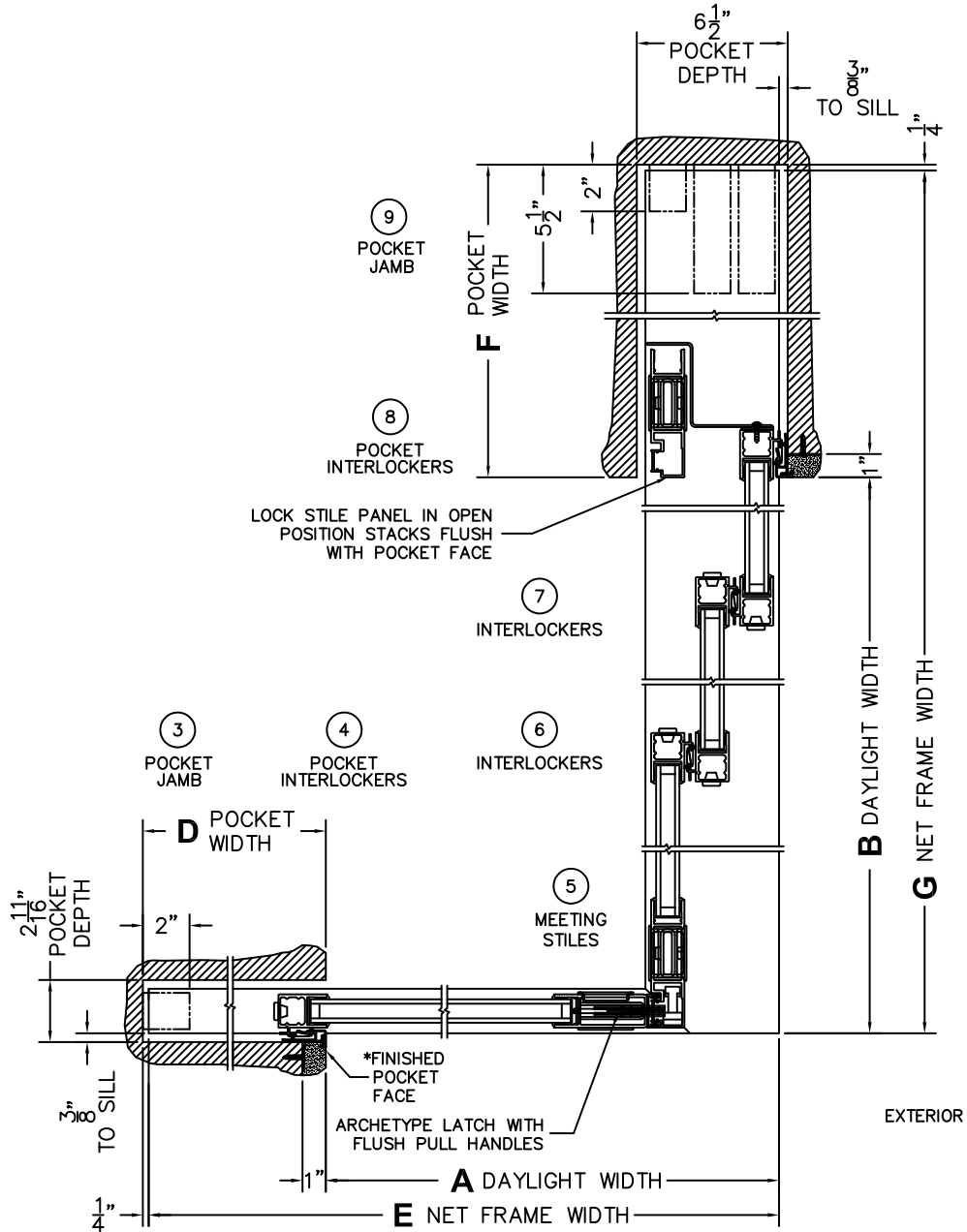

*CAUTION: WHEN CONSTRUCTING POCKET NOTE THAT DAYLIGHT WIDTH DOES NOT INCLUDE 1" SET BACK FOR POST INTERLOCKER.